

312D/312D L

Hydraulic Excavator

CATERPILLAR®



Cat® C4.2 Engine with ACERT™ Technology

Net Power (ISO 9249) at 2200 rpm 67 kW/91 hp

Operating Weights

312D L (long undercarriage) 13 470 kg

*Long undercarriage, 500 mm shoes,
3000 mm stick, 0.52 m³ bucket.*

312D/312D L Features

Comfortable Operator Station

Spacious and quiet, this world class cab lets the operator focus on performance and productivity.

Engine Power Combined with Low Emissions

Move more material and respect the environment while using less fuel with the Cat C4.2 ACERT engine. The 312D meets EU Stage IIIA emissions regulations while providing additional power and performance.

Efficient Hydraulics

The performant hydraulic system delivers more power for increased digging force, lifting ability and overall productivity.

Maximum Versatility

Easily configure a large variety of work tools with the Cat Tool Control System.

Proven Reliability

Caterpillar design and manufacturing techniques provide maximum uptime with outstanding durability and service life.

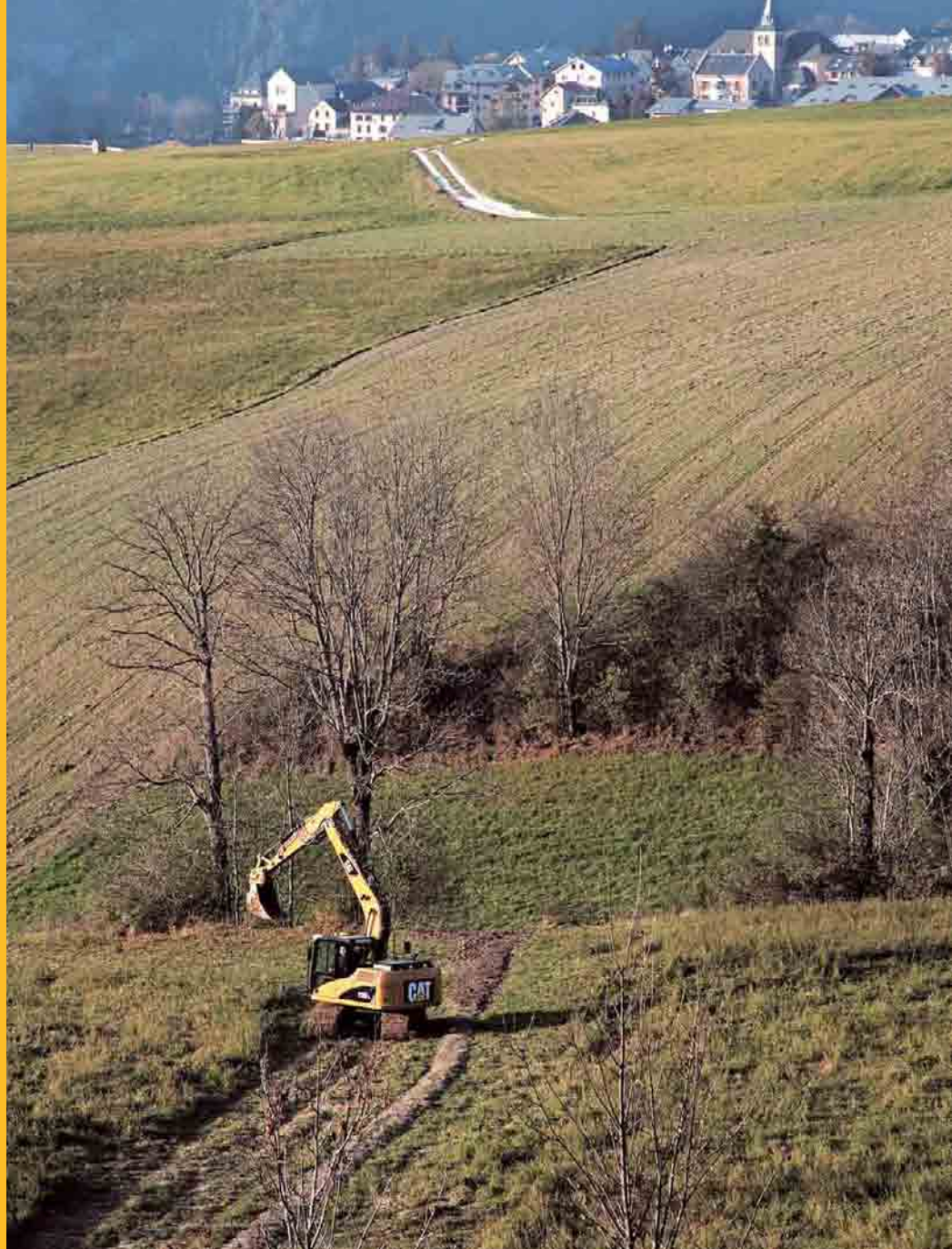

Contents

Operator Station	3
Engine	4
Hydraulics	5
Undercarriage/Structures	6
Front Linkage	6
Versatility	7
Serviceability	8
Cat Product Link	9
Customer Support	9
Specifications	10
Standard Equipment	26
Optional Equipment	27

Achieve high productivity and lower operating costs with the Cat 312D and 312D L hydraulic excavators. Unmatched versatility, improved controllability, easy operation and a comfortable redesigned cab make the 312D the industry leading performer.

Operator Station

Enhanced comfort, operation and visibility

Operator Comfort

Experience a spacious, quiet and comfortable operator station. The cab is pressurized to 0.5 bar to reduce the amount of dust that enters the cab, keeping the operator comfortable during the entire shift, while assuring high productivity.

- The comfortable seat adjusts to the operator's size and weight, and the armrests are also height adjustable.
- The new seat has been designed to feature air-suspension and heating systems. Both these attachments are optionally available.
- Low effort joystick controls are designed to match the operator's natural wrist and arm position. Joysticks can be operated with arms on the armrests. The horizontal and vertical strokes are designed to reduce fatigue.
 - To best suit your needs, two windshield options are available:
70/30 split: the front windshield is split 70 (upper)/30 (lower) in order to provide maximum visibility. The upper part is slidable, assisted by a mechanism which reduces operator effort.
 - One piece highly resistant windshield (10 mm thick).

Cab Exterior

The Falling Object Guard System (FOGS) can be directly bolted to the cab, enabling the machine to meet all specifications and job site requirements. Thicker steel tubes made according to the solid drawn process contribute to the rigidity of the 312D operator station.

Pre-start Check and Monitor Display

Take advantage of the entirely rethought monitor, designed to simplify machine use by acting as a operator-to-machine interface. It features:

- Full color graphical display
- An on-board servicing scheduler (displaying recommended actions such as oil and filter changes)
- 20 different available languages
- Video display capability

Cat Machine Security System

An optional Machine Security System (MSS) utilizes a programmable key, deterring theft, vandalism and unauthorized usage. MSS uses electronically coded keys selected by the customer to limit usage by individuals or time parameters.



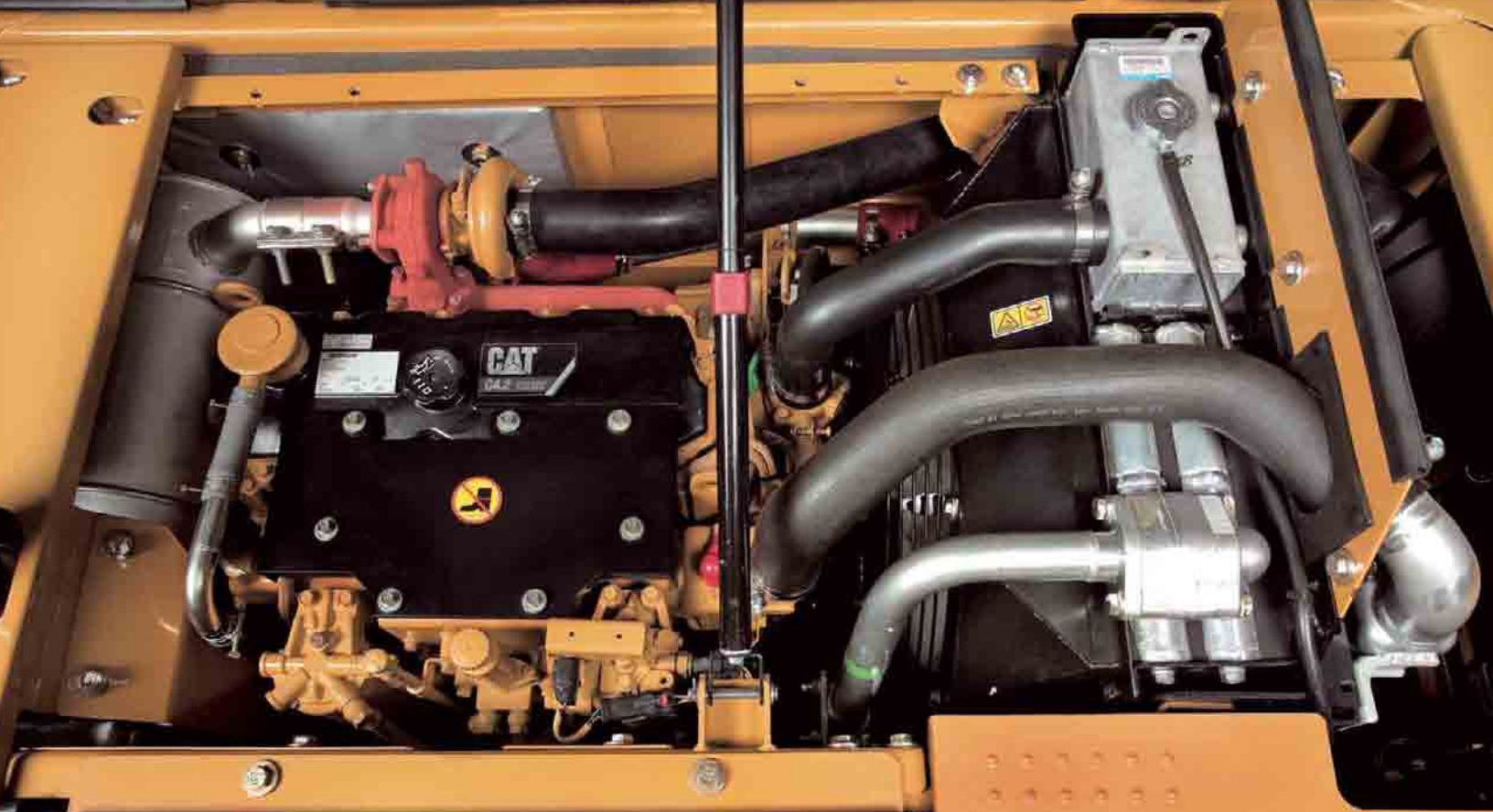

Engine

A clean, quiet and powerful engine helps to deliver the most work per liter of fuel consumed.

The Cat C4.2 engine with ACERT Technology optimizes performance and meets EU Stage IIIA emissions regulations. In conjunction with integrated electronics, ACERT Technology reduces emissions during the combustion process by using advanced technology in the air and fuel systems. The Cat C4.2 engine delivers exceptional power, allowing more hydraulic pressure to drive productivity and reduce your cost per ton of material moved.

Fuel Economy

- **Automatic Engine Control, Fuel Delivery and Manual Low Idle Function.** A two-level control with one-touch command maximizes fuel efficiency and reduces sound levels during no-load or lighter-load applications. Fuel delivery is managed by the ADEM A4 Engine Controller for the best performance per liter of fuel used. Flexible fuel mapping allows the engine to respond quickly to varying application needs. Electronic controls govern the fuel injection system. Multiple injection fuel delivery involves a high level of precision. Consequently, the carefully shaped combustion cycle lowers the combustion chamber temperatures, generates fewer emissions and thus optimizes fuel consumption. For you, this means more work output for the same amount of fuel consumed.

- **Economy Mode.** A new Economy Mode function is now available: thanks to this device, you can adapt the performance of the machine to the work that needs to be done. By using a menu in the monitor, decide, whether you want to switch the Economy Mode on or off, and thus choose whether you want to operate fuel-efficiently or whether you want to use the full power of the machine, in order to boost productivity.
- **ODPS.** On Demand Power Supply is a new feature, constantly regulating engine power supply, based on the power demanded by the machine hydraulic system. This machine reduces fuel consumption and machine noise in light duty applications.

Crankshaft and Pistons

A forged one-piece, induction hardened crankshaft enhances balance, decreases vibration and improves abrasion resistance. Heat resistant, aluminum alloy pistons have a short compression height for greater efficiency and longer life.

Electronic Control Module (ECM)

The ECM works as the “brain” of the engine’s control system, responding quickly to the operating variables to maximize engine efficiency. Fully integrated with sensors in the engine’s fuel, air, coolant and exhaust systems, the ECM stores and relays data on conditions such as rpms, fuel consumption and diagnostics.

Hydraulics

Low effort and precise control for highly efficient performance.



Outstanding Performance

With two percent more hydraulic pressure for additional lift and breakout forces, the 312D's hydraulic system is designed for high efficiency and performance. The new compact design utilizes shorter tubes and lines, reducing friction and pressure drops, resulting in a more efficient use of power.

- Hydraulic snubbers at the rod end of the boom cylinders and both ends of the stick cylinder cushion shock, reduce sound and increase cylinder life.
- Flow is reduced to a minimum when controls are in neutral to reduce fuel consumption and extend component life.
- Electronic under speed control electronically adjusts pump output so that it doesn't exceed engine power, preventing the need to reserve engine power to avoid engine stalls.
- Hydraulic cross sensing system uses two more hydraulic pumps up to 100 percent of engine power under all operating conditions, improving productivity with faster implement speeds and quicker, stronger pivot turns.

Boom and Stick Regeneration Circuit

The boom and stick regeneration circuit saves energy during boom-down and stick-in operation, increasing efficiency and lowering operating costs. What is more, regeneration during boom down operations is electronically assisted. This system increases hydraulic flow regeneration, which leads to faster operations and reduced pressure loss, and hence improved fuel efficiency.

Easy Operation

Work mode and power mode switches are eliminated making full power mode available at all times. Operators do not need to learn different modes, an automatic boom and swing priority function automatically selects the best mode based on joystick movement.

Two Pump Flow

The two pump combined option, available with the single action control circuit option, allows for increased productivity in single action applications.

Undercarriage and Structures

Strong, stable and easy to maneuver.



Caterpillar uses advanced engineering and software to analyze all structures, creating a durable, reliable machine for the toughest applications. More than 70 percent of the structural welds are robotic and achieve over three times the penetration of manual welds. These structural components and undercarriage are the backbone of the machine's durability.

Standard or Long Undercarriage

The 312D will continue to be available in two different undercarriage versions: according to your needs, choose between:

- The 312D (standard undercarriage), which has a track length of 3490 mm
- The 312D L (long undercarriage) which has a track length of 3750 mm

Blades

Two blades (2490 mm and 2780 mm) are optionally available with the 312D and 312D L for improved stability and lifting ability

Improved Drawbar Pull

Drawbar pull has increased by 5%, which results in higher system pressure tolerance, so that you can enjoy improved maneuverability on slopes and in muddy underfoot conditions.

Carbody Design

X-shaped, box section carbody provides excellent resistance to torsional bending. Robot-welded track roller frames are press-formed, pentagonal units that deliver exceptional strength and service life. Idler and center guards are available to help maintain track alignment when traveling or working on slopes.

Travel Motors

Travel Motors with automatic speed selection let the 312D automatically change up and down from high and low speeds in a smooth controlled manner.

Grease Lubricated Tracks

Grease lubricated track seals protect the track link and deliver long track pin and bushing inner wear.

Front Linkage

Reliable, durable and versatile.

Built for performance and long service life, Cat booms and sticks are welded, box section structures with thick multi plate high strength steel fabrications. Service intervals are extended with self lubricating pins that resist corrosion and galling for superior durability.

Reach Boom

The 4650 mm reach boom is designed for maximum digging capability and is robotic welded to ensure consistent quality. This allows excellent all around versatility and a large working envelope.

Optional Variable Angle Boom

An optional VA boom will continue to be available for the 312D, to suit all your applications in small space conditions, and thus achieve greater versatility.

Stick

Three stick lengths are available (2100 mm, 2500 mm and 3000 mm), in order to offer maximum flexibility in machine configuration and therefore to meet a wide range of applications. What is more, all the boom and stick linkages of the 312D are compatible with those of the 312C.



Versatility

More options for more work.

Hydraulic and Pilot Configurations

High pressure systems, medium pressure systems and hydraulic controls are available as independent and combinable attachments to configure the most adapted machine to your specific job needs.

Control Levers

An optional foot switch is available. This switch has two positions: ON/OFF, and does not provide modulation. Alternatively, an optional pedal provides foot pedal modulation.

Work Tools

Caterpillar offers a variety of work tools including hammers, grapples, multiprocessors, shears, pulverizers, and vibratory compactors to fit your application needs. Additionally, a wide range of buckets are available to optimize machine performance. Auxiliary hydraulic and electrical lines are routed to the boom foot for easier installation of auxiliary hydraulic circuits, therefore reducing time, part and cost required to add a work tool. Furthermore, all pins are interchangeable between the C and the D series models.

Tool Control

The Tool Control attachment is standard and offers up to 10 flow and pressure pre-settings, for easier and quicker tool readiness. Combined with the Quick Coupler, the tool control system allows you to change from one hydraulic work tool to the next without having to leave the cab.

Quick Coupler

This hydraulic tool holder increases machine versatility by making the change from one hydraulic work tool to another quick and easy. Moreover, a Universal Quick Coupler control now accepts all hydraulic Quick Coupler systems with pressures ranging up to full machine pressure (350 bar).

Medium Pressure Circuit

The Medium Pressure Circuit is available as an attachment for work tools requiring moderate hydraulic flow, such as rotating buckets or shears.

Cat Product Link

The 312D is pre-wired to accept Product Link systems to install in the field or to order from the factory. Product Link assists with fleet management by tracking hours, location and machine health.

High Ambient Cooling Package

Thanks to the new EU compliant High Ambient Cooling Package, take the machine to work in temperatures up to 48 °C.



Serviceability

Simplified service and maintenance saves time and money.

Designed with the service technician in mind, many service locations are at ground level so critical maintenance can be done quickly and efficiently. Longer maintenance intervals reduce cost and increase machine availability.

- Oil level gauge, fuel filter and priming pump are conveniently located on the right side of the engine structure for easy maintenance.
- An optional electronic fuel water sensor is available to alert the operator when the water level is high.
- The Product Link assists with fleet management by tracking hours, location and product health.
- New anti skid plates over the top of the storage box and upper structure help prevent slipping and mud from falling into the upper structure.

Water Separator with Indicator

An optional water Separator with level indicator is optionally available, to alert the operator when the water level is high.

Sampling Ports

Equipped with S•O•S sampling ports and test ports for hydraulics, engine oil and coolant for quick diagnostics. A test connection for the Cat Electronic technician (Cat ET) service tool is now located in the cab.

Air Cleaner

A double layered filter core in the radial seal air filter gives more efficient filtration. A warning is displayed on the monitor when dust accumulates above a preset level. This filter is conveniently located in the compartment behind the cab.

Capsule Filter

Capsule-type, hydraulic return oil filter is accessible from outside the tank and prevents contaminants from entering the system during hydraulic oil changes.



Customer Support

Unmatched support makes the difference.

Your Cat dealer is ready to assist you with your purchase decision and everything after.

- Make detailed comparisons of the machines you are considering before you buy with estimates of component life, preventive maintenance and the true cost of production
- Customize the machine that is right for you by using Build and Quote applications on your dealer's website or www.cat.com
- Get the latest training literature and trained staff
- Repair option programs guarantee the cost of repairs upfront
- Nearly all parts are available at dealer parts counters
- Financing packages are flexible to meet your needs
- Your Cat dealer can evaluate the cost involved in repairing, rebuilding and replacing your machine so you can make the right choice.



Cat Product Link

Efficient feature to follow and support your machine anywhere.

The 312D/312D L can be equipped with Product Link PL321SR as optional feature.

This system provides permanent location, operating hours and machine health information through GPS ways and Internet tools.

Product Link improves machine availability and lowers operating costs.



312D/312D L Hydraulic Excavator Specifications

Engine

Engine Model	Cat® C4.2 ACERT™
Gross Power	72 kW/98 hp
Net Power	
ISO 9249	67 kW/91 hp
80/1269/EEC	67 kW/91 hp
Bore	102 mm
Stroke	130 mm
Displacement	4.25 liter

- All engine horsepower (hp) are metric including front page.
- Net power advertised is the power available at the flywheel when the engine is equipped with fan, air cleaner, muffler and alternator.
- No engine derating required below 2300 m altitude.
- The 312D/312D L meet EU Stage IIIA Directive 97/68/EC emissions requirements.

Hydraulic System

Main Implement System	
Maximum Flow (2x)	127 l/min
Maximum Pressure	
Implements	305 bar
Travel	350 bar
Swing	230 bar
Pilot System	
Maximum Flow	22 l/min
Maximum Pressure	41 bar
Boom Cylinders	
Bore	110 mm
Stroke	1015 mm
Stick Cylinder	
Bore	120 mm
Stroke	1197 mm
Bucket Cylinder	
Bore	100 mm
Stroke	939 mm

Sound

Operator Sound

- The operator sound pressure level measured according to the procedures specified in ISO 6396:1992 is 72 dB(A), for cab offered by Caterpillar, when properly installed and maintained and tested with the doors and windows closed.

Exterior Sound

- The European Union 2000/14/EC labeled exterior sound power level is 98 dB(A) for the machines certified to that requirement.

Operating Weights

Weights will depend on final machine configuration.

Reach Boom

Stick	Short	Medium	Long	Short	Medium	Long
	2100 mm	2500 mm	3000 mm	2100 mm	2500 mm	3000 mm
	Without Blade			With Blade		
312D	kg	kg	kg	kg	kg	kg
500 mm triple grouser shoes	12 860	12 900	12 920	13 650	13 690	13 720
600 mm triple grouser shoes	13 090	13 130	13 150	16 890	13 930	13 950
700 mm triple grouser shoes	13 340	13 380	13 410	14 150	14 190	14 220
770 mm triple grouser shoes	13 480	13 520	13 540	14 290	14 330	14 350
312D L						
500 mm triple grouser shoes	13 410	13 180	13 200	13 930	13 970	14 000
600 mm triple grouser shoes	13 390	13 430	13 450	14 180	14 220	14 250
700 mm triple grouser shoes	13 660	13 700	13 720	14 470	14 510	14 530
770 mm triple grouser shoes	13 800	13 840	13 870	14 610	14 650	14 680

Dimensions with Reach Boom and VA Boom

All dimensions are approximate.

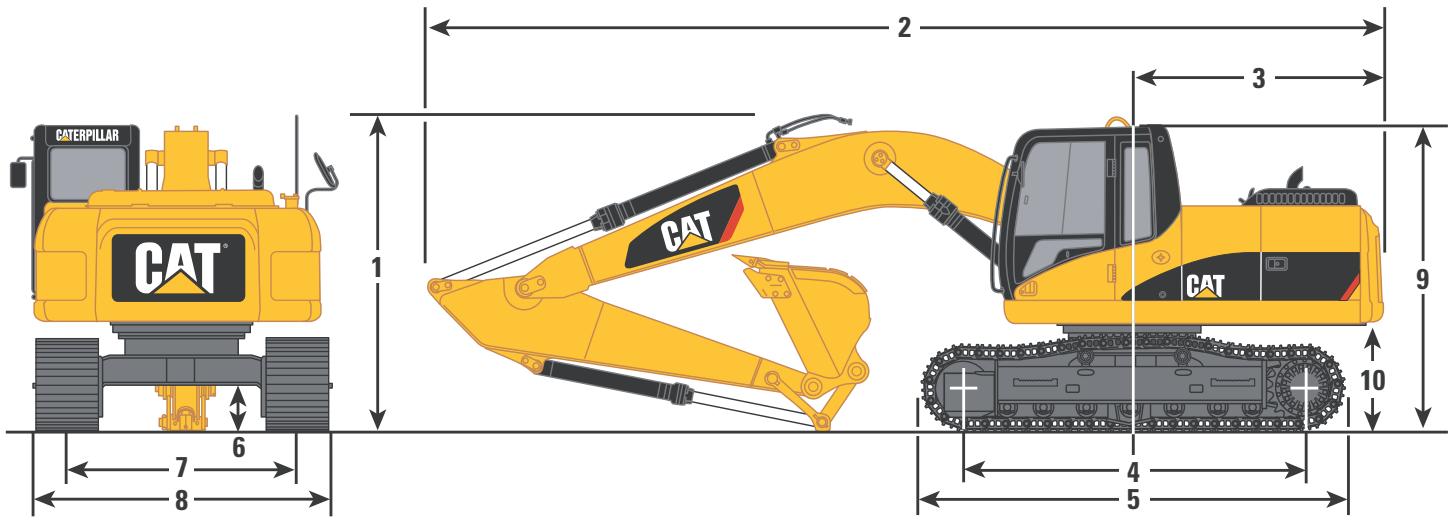

Boom Stick	mm	Reach Boom			VA Boom		
		2100	2500	3000	2100	2500	3000
1 Shipping height	mm	2830	2970	2830	2830	2970	2830
2 Shipping length	mm	7610	7590	7610	7610	7590	7610
3 Tail swing radius	mm	2140	2140	2140	2140	2140	2140
4 Length to centers of idler and sprocket							
312D	mm	2780	2780	2780	2780	2780	2780
312D L	mm	3040	3040	3040	3040	3040	3040
5 Track length							
312D	mm	3490	3490	3490	3490	3490	3490
312D L	mm	3750	3750	3750	3750	3750	3750
6 Ground clearance	mm	430	430	430	430	430	430
7 Track gauge	mm	1990	1990	1990	1990	1990	1990
8 Transport width (500 mm shoes)	mm	500	600	700	500	600	700
312D	mm	2490	2590	2690	2490	2590	2690
312D L	mm	2490	2590	2690	2490	2590	2690
9 Cab height	mm	2760	2760	2760	2760	2760	2760
10 Counterweight clearance	mm	915	915	915	915	915	915

Swing Mechanism

Maximum Swing Torque	31 kNm
Maximum Swing Speed	12.4 rpm

Drive

Maximum Drawbar Pull	114 kN
Maximum Travel Speed	5.5 km/h

Service Refill Capacities

	liter
Fuel Tank	250
Cooling System	18
Engine Oil	20
Swing Drive	3
Final Drive (each)	3
Hydraulic System (including tank)	162
Hydraulic Tank	150

Cab/FOGS

Bolt-on Falling Object Guard System (FOGS) is available as an attachment. Optional Falling Object Guard System is designed to protect the operator from falling objects, and is certified under ISO 3449-1984 specifications.

312D/312D L Hydraulic Excavator Specifications

Bucket Specifications

Without Quick Coupler	Width	Capacity (ISO)	Weight*	312D			312D L		
	mm	m ³	kg	2100 mm	2500 mm	3000 mm	2100 mm	2500 mm	3000 mm
Excavation	600	0.28	316						
	750	0.38	336						
	900	0.49	375						
	1000	0.56	397						
	1100	0.64	430						
	1200	0.72	453						
Extreme Excavation	500	0.21	314						
	1200	0.72	463						
Maximum load in kg (payload plus bucket)				1720	1592	1402	1764	1633	1439
With Quick Coupler									
Excavation	450	0.18	301						
	500	0.21	310						
	600	0.28	330						
	750	0.38	340						
	900	0.49	375						
	1000	0.56	398						
	1100	0.64	432						
	1200	0.72	455			N			N
Extreme Excavation	500	0.21	312						
	600	0.28	334						
	1200	0.72	465			N			N
Maximum load in kg (payload plus bucket)				1720	1592	1402	1764	1633	1439

- Max. Material Density 1200 kg/m³
- Max. Material Density 1500 kg/m³
- Material Density 1800 kg/m³ and more
- N Not recommended

* Bucket weight including penetration plus tips

Typical Material Densities

Clay, dry	1500	Rock/dirt, 50%	1720
Clay, wet	1660	Sand, dry	1425
Earth, dry	1510	Sand, wet	1700
Earth, wet	1600	Sand and clay	1600
Loam	1250	Stone, crushed	1600
Gravel, dry	1510	Top soil	950
Gravel, wet	2000		
Gravel, pit run	1930		

* Kilograms per loose cubic meter

Work Tools Matching Guide

When choosing between various work tool models that can be installed onto the same machine configuration, consider work tool application, productivity requirements, and durability. Refer to work tool specifications for application recommendations and productivity information.

Without quick coupler		312D			312D L		
		mm	2100	2500	3000	2100	2500
Hammers	H90C						
	H100C						
	H115 S						
Hydraulic Shear (boom mounted)	S320						
Multi-Grapples	G310B-D						
	G310B-R						
Vibratory Plate Compactor	CVP75						
Orange Peel Grapples	5 tines GSH9B-300						
	4 tines GSH9B-300						
	5 tines GSH9B-400						
	4 tines GSH9B-400						
	5 tines GSH15B-400		×	×			
	4 tines GSH15B-400			×			
	5 tines GSH15B-500	×	×	×			
	4 tines GSH15B-500		×	×			
	5 tines GSH15B-600	×	×	×			×
	4 tines GSH15B-600	×	×	×			
	5 tines GSH15B-800	×	×	×		×	×
	4 tines GSH15B-800	×	×	×			×
Rehandling Clamshell Buckets	GOS20-220						
	GOS20-260						
	GOS20-300						
	GOS20-400						
	GOS20-560						
	GOS20-680						
	GOS20-730						
	GOS25-460						
	GOS25-520						
	GOS25-580						
	GOS25-750			×			
	GOS25-900	×	×	×			
	GOS25-990	×	×	×			
	GOS25-1140	×	×	×			×
With quick coupler							
Quick Coupler	CW-20						
	CW-20s						
Hammers	H90C						
	H100C						
	H115 S						
Multi-Grapples	G310B-D		×	×		×	×
	G310B-R		×	×		×	×
Vibratory Plate Compactor	CVP75						

Maximum Material density 3000 kg/m³

Maximum Material density 1800 kg/m³

Maximum Material density 1200 kg/m³

×

Not Compatible

360° Working Range

Over the front only

Available

312D/312D L Hydraulic Excavator Specifications

Working Ranges with Reach Boom

All measurements are approximate

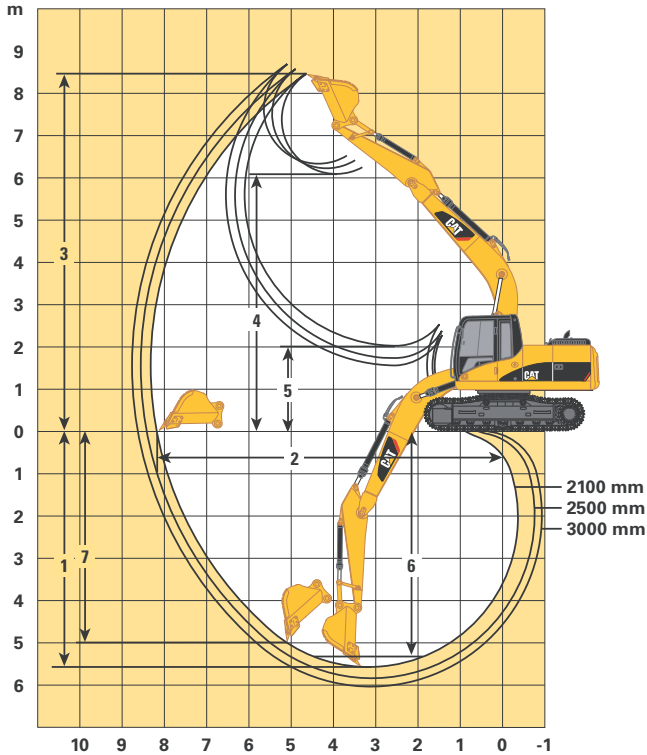

Stick Options	mm	2100	2500	3000
Bucket	m³	0.52	0.52	0.52
1 Maximum Digging Depth	mm	5540	5840	6040
2 Maximum Reach at Ground Level	mm	8170	8430	8620
3 Maximum Cutting Height	mm	8480	8580	8700
4 Maximum Loading Height	mm	6100	6210	6340
5 Minimum Loading Height	mm	2020	1730	1530
6 Maximum Depth Cut for 2.50 m Level Bottom	mm	5330	5640	5850
7 Maximum Vertical Wall Digging Depth	mm	4980	5160	5360
Stick Digging Force (ISO 6015)	kN	66	62	59
Bucket Digging Force (ISO 6015)	kN	96	96	96

Working Ranges with VA Boom

All measurements are approximate

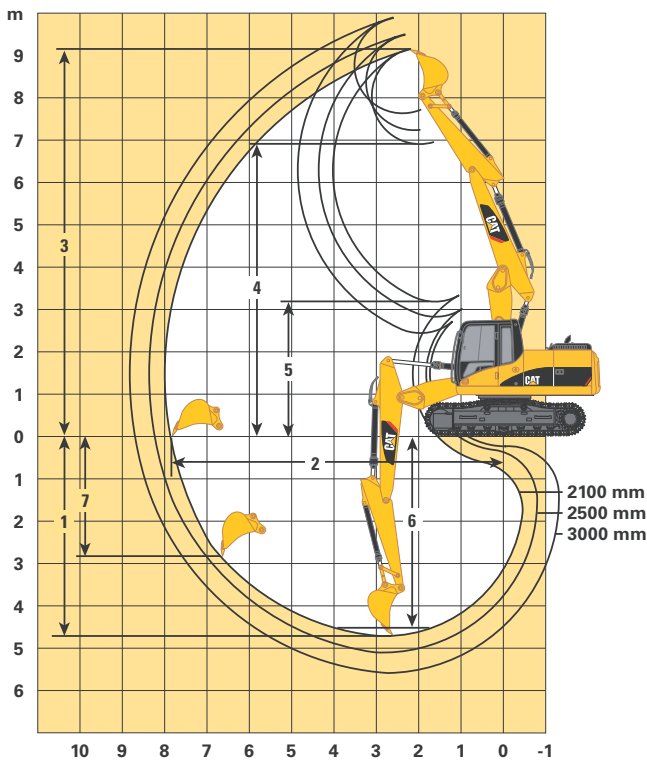

Stick Options	mm	2100	2500	3000
Bucket	m³	0.68	0.68	0.68
1 Maximum Digging Depth	mm	4731	5128	5612
2 Maximum Reach at Ground Level	mm	7836	8223	8677
3 Maximum Cutting Height	mm	9140	9489	9887
4 Maximum Loading Height	mm	6914	7268	7649
5 Minimum Loading Height	mm	3188	2835	2439
6 Maximum Depth Cut for 2.50 m Level Bottom	mm	4538	4904	5341
7 Maximum Vertical Wall Digging Depth	mm	2844	3160	3643

Lift Capacities with Reach Boom

All weights are in kg. Calculations are made without bucket, but with CW20 Quick Coupler.

312D
Short stick – 2100 mm
Shoes – 600 mm
Standard counterweight – 2450 kg
No Blade

Reach (m)	1.5 m		3.0 m		4.5 m		6.0 m		7.5 m		Load at Maximum Reach		m
	Load Point Height	Load Radius Over Front	Load Radius Over Front	Load Radius Over Side	Load Radius Over Front	Load Radius Over Side	Load Radius Over Front	Load Radius Over Side	Load Radius Over Front	Load Radius Over Side	Load at Maximum Reach	Load at Maximum Reach	
6.0 m					*2700	*2700					*2430	*2430	5.19
4.5 m					*3480	*3480	*2870	2280			*2230	2130	6.22
3.0 m			*5830	*5830	*4230	3510	3130	2220			*2220	1810	6.77
1.5 m			*6460	5920	4710	3260	3030	2130			*2340	1690	6.95
0 m			*5600	*5600	4520	3090	2940	2050			2450	1710	6.8
-1.5 m	*4920	*4920	*5800	5600	4450	3020	2910	2020			2730	1900	6.29
-3.0 m	*5350	*5350	*6760	5720	4500	3070					3530	2450	5.33

312D
Medium stick – 2500 mm
Shoes – 600 mm
Standard counterweight – 2450 kg
No Blade

Reach (m)	1.5 m		3.0 m		4.5 m		6.0 m		7.5 m		Load at Maximum Reach		m
	Load Point Height	Load Radius Over Front	Load Radius Over Front	Load Radius Over Side	Load Radius Over Front	Load Radius Over Side	Load Radius Over Front	Load Radius Over Side	Load Radius Over Front	Load Radius Over Side	Load at Maximum Reach	Load at Maximum Reach	
6.0 m											*1970	*1970	5.69
4.5 m					*3130	*3130	*3030	2340			*1830	*1830	6.64
3.0 m			*5100	*5100	*3920	3580	3170	2270			*1820	1670	7.15
1.5 m			*7770	6120	4790	3330	3060	2160			*1910	1570	7.33
0 m			*5940	5720	4570	3140	2960	2070			*2130	1580	7.19
-1.5 m	*4490	*4490	*5930	5640	4470	3050	2910	2020			2490	1730	6.71
-3.0 m	*5270	*5270	*6650	5710	4490	3060					3090	2150	5.81
-4.5 m			*5870	*5870									

312D
Long stick – 3000 mm
Shoes – 600 mm
Standard counterweight – 2450 kg
No Blade

Reach (m)	1.5 m		3.0 m		4.5 m		6.0 m		7.5 m		Load at Maximum Reach		m
	Load Point Height	Load Radius Over Front	Load Radius Over Front	Load Radius Over Side	Load Radius Over Front	Load Radius Over Side	Load Radius Over Front	Load Radius Over Side	Load Radius Over Front	Load Radius Over Side	Load at Maximum Reach	Load at Maximum Reach	
7.5 m											*2040	*2040	4.77
6.0 m							*2290	*2290			*1730	*1730	6.25
4.5 m							*2770	2370			*1620	*1620	7.12
3.0 m					*3430	*3430	*3110	2280	*1990	1540	*1620	1500	7.61
1.5 m			*6860	6290	*4510	3360	3060	2160	2140	1490	*1700	1400	7.77
0 m			*6650	5740	4570	3130	2940	2050	2090	1450	*1890	1410	7.64
-1.5 m	*4140	*4140	*6220	5560	4430	3000	2870	1980			2210	1520	7.19
-3.0 m	*5270	*5270	*6670	5580	4410	2980	2870	1980			2650	1830	6.37
-4.5 m			*6870	5760	*4470	3090					*3790	2700	4.97

312D
Short stick – 2100 mm
Shoes – 600 mm
Heavy counterweight – 2650 kg
No Blade

Reach (m)	1.5 m		3.0 m		4.5 m		6.0 m		7.5 m		Load at Maximum Reach		m
	Load Point Height	Load Radius Over Front	Load Radius Over Front	Load Radius Over Side	Load Radius Over Front	Load Radius Over Side	Load Radius Over Front	Load Radius Over Side	Load Radius Over Front	Load Radius Over Side	Load at Maximum Reach	Load at Maximum Reach	
6.0 m					*2700	*2700					*2430	*2430	5.19
4.5 m					*3480	*3480	*2870	2370			*2230	2220	6.22
3.0 m			*5830	*5830	*4230	3630	3230	2310			*2220	1890	6.77
1.5 m			*6460	6140	4870	3390	3130	2220			*2340	1760	6.95
0 m			*5600	*5600	4670	3210	3040	2140			2540	1780	6.8
-1.5 m	*4920	*4920	*5800	*5800	4610	3150	3020	2110			2830	1980	6.29
-3.0 m	*5350	*5350	*6760	5940	4660	3200					3650	2550	5.33



Load Point Height



Load Radius Over Front



Load Radius Over Side



Load at Maximum Reach

* Limited by hydraulic rather than tipping load.

The above loads are in compliance with hydraulic excavator lift capacity ratings standard ISO 10567, they do not exceed 87% of hydraulic lifting capacity or 75% of tipping capacity. Weight of all lifting accessories must be deducted from the above lifting capacities.















312D/312D L Hydraulic Excavator Specifications

Lift Capacities with Reach Boom

All weights are in kg. Calculations are made without bucket, but with CW20 Quick Coupler.















312D

Medium stick – 2500 mm
Shoes – 600 mm
Heavy counterweight – 2650 kg
No Blade

	1.5 m		3.0 m		4.5 m		6.0 m		7.5 m					
													m	
6.0 m												*1970	*1970	5.69
4.5 m					*3130	*3130	*3030	2420				*1830	*1830	6.64
3.0 m					*5100	*5100	*3920	3710	3280	2350		*1820	1740	7.15
1.5 m					*7770	6350	*4940	3460	3170	2250		*1910	1640	7.33
0 m					*5940	*5940	4730	3260	3070	2160		*2130	1650	7.19
-1.5 m	*4490	*4490	*5930	5860	4630	3170	3020	2110				*2550	1810	6.71
-3.0 m	*5270	*5270	*6650	5930	4650	3190						3200	2240	5.81
-4.5 m			*5870	*5870										















312D

Long stick – 3000 mm
Shoes – 600 mm
Heavy counterweight – 2650 kg
No Blade

	1.5 m		3.0 m		4.5 m		6.0 m		7.5 m								
													m				
7.5 m												*2040	*2040	4.77			
6.0 m							*2290	*2290				*1730	*1730	6.25			
4.5 m							*2770	2450				*1620	*1620	7.12			
3.0 m							*3430	*3430	*3110	2370	*1990	1610	*1620	1560	7.61		
1.5 m							*6860	6520	*4510	3490	3170	2250	2220	1560	*1700	1470	7.77
0 m							*6650	5970	4730	3260	3050	2140	2170	1520	*1890	1470	7.64
-1.5 m	*4140	*4140	*6220	5780	4580	3130	2980	2070				*2230	1590	7.19			
-3.0 m	*5270	*5270	*6670	5800	4560	3110	2980	2070				2750	1920	6.37			
-4.5 m			*6870	5980	*4470	3220						*3790	2810	4.97			















312D L

Short stick – 2100 mm
Shoes – 600 mm
Standard counterweight – 2450 kg
No Blade

	1.5 m		3.0 m		4.5 m		6.0 m		7.5 m						
													m		
6.0 m												*2870	*2870	5.45	
4.5 m							*3850	*3850	*3690	2510		*2590	2200	6.47	
3.0 m							*4780	3720	3740	2430		*2540	1900	7.01	
1.5 m							5590	3460	3630	2330		*2620	1800	7.18	
0 m							5400	3300	3540	2250		2850	1830	7.01	
-1.5 m							*8290	5950	5360	3260	3520	2230	3180	2030	6.48
-3.0 m							*8200	6090	5430	3320		4090	2590	5.47	

312D L

Medium stick – 2500 mm
Shoes – 600 mm
Standard counterweight – 2450 kg
No Blade

	1.5 m		3.0 m		4.5 m		6.0 m		7.5 m					
													m	
7.5 m												*2920	*2920	4.25
6.0 m												*2320	*2320	5.94
4.5 m												*2130	2020	6.88
3.0 m												*2100	1780	7.38
1.5 m												*2170	1690	7.55
0 m												*2370	1710	7.39
-1.5 m	*4120	*4120	*7760	5970	5380	3280	3520	2230				*2780	1870	6.89
-3.0 m	*7620	*7620	*8890	6070	5410	3310						3610	2300	5.95



Load Point Height



Load Radius Over Front



Load Radius Over Side



Load at Maximum Reach

* Limited by hydraulic rather than tipping load.

The above loads are in compliance with hydraulic excavator lift capacity ratings standard ISO 10567, they do not exceed 87% of hydraulic lifting capacity or 75% of tipping capacity. Weight of all lifting accessories must be deducted from the above lifting capacities.

Lift Capacities with Reach Boom

All weights are in kg. Calculations are made without bucket, but with CW20 Quick Coupler.













312D L

Long stick – 3000 mm

Shoes – 600 mm

Standard counterweight – 2450 kg

No Blade

	1.5 m		3.0 m		4.5 m		6.0 m		7.5 m				m	
														
7.5 m												*2400	*2400	5.02
6.0 m							*2990	2600				*2020	*2020	6.5
4.5 m							*3030	2580				*1890	1820	7.36
3.0 m					*3910	3860	*3440	2490	2680	1740		*1880	1610	7.84
1.5 m					*5170	3570	3670	2360	2620	1690		*1950	1530	7.99
0 m			*5540	*5540	5460	3340	3550	2250	2570	1640		*2120	1540	7.84
-1.5 m	*3820	*3820	*7410	5880	5330	3230	3480	2190				*2470	1670	7.37
-3.0 m	*6560	*6560	*9460	5930	5330	3230	3490	2200				3130	1990	6.51
-4.5 m			*7200	6140	*4670	3360						*3790	2890	5.05













312D L

Short stick – 2100 mm

Shoes – 600 mm

Standard counterweight – 2450 kg

Blade up

	1.5 m		3.0 m		4.5 m		6.0 m		7.5 m				m	
														
6.0 m					*3570	*3570						*2870	*2870	5.45
4.5 m					*3850	*3850	*3690	2620				*2590	2310	6.47
3.0 m					*4780	3890	3720	2550				*2540	2000	7.01
1.5 m					5550	3630	3600	2450				*2620	1890	7.18
0 m					5370	3470	3520	2370				2830	1930	7.01
-1.5 m			*8290	6250	5320	3430	3490	2350				3150	2140	6.48
-3.0 m			*8200	6390	5390	3490						4070	2720	5.47













312D L

Medium stick – 2500 mm

Shoes – 600 mm

Standard counterweight – 2450 kg

Blade up

	1.5 m		3.0 m		4.5 m		6.0 m		7.5 m				m	
														
7.5 m												*2920	*2920	4.25
6.0 m												*2320	*2320	5.94
4.5 m					*3480	*3480	*3410	2670				*2130	2120	6.88
3.0 m			*6230	*6230	*4440	3970	3760	2590				*2100	1870	7.38
1.5 m					*5620	3710	3640	2480	*2520	1790		*2170	1780	7.55
0 m			*4770	*4770	5420	3520	3540	2390				*2370	1800	7.39
-1.5 m	*4120	*4120	*7760	6270	5340	3450	3500	2350				*2780	1970	6.89
-3.0 m	*7620	*7620	*8890	6370	5380	3480						3590	2420	5.95













312D L

Long stick – 3000 mm

Shoes – 600 mm

Standard counterweight – 2450 kg

Blade up

	1.5 m		3.0 m		4.5 m		6.0 m		7.5 m				m	
														
7.5 m												*2400	*2400	5.02
6.0 m							*2990	2720				*2020	*2020	6.5
4.5 m							*3030	2700				*1890	*1890	7.36
3.0 m					*3910	*3910	*3440	2610	2660	1830		*1880	1700	7.84
1.5 m					*5170	3740	3650	2480	2600	1780		*1950	1610	7.99
0 m			*5540	*5540	5420	3510	3520	2370	2550	1740		*2120	1630	7.84
-1.5 m	*3820	*3820	*7410	6180	5300	3400	3450	2310				*2470	1760	7.37
-3.0 m	*6560	*6560	*9460	6240	5290	3400	3460	2310				3100	2090	6.51
-4.5 m			*7200	6440	*4670	3530						*3790	3040	5.05

312D/312D L Hydraulic Excavator Specifications

Lift Capacities with Reach Boom

All weights are in kg. Calculations are made without bucket, but with CW20 Quick Coupler.















312D L

Short stick – 2100 mm

Shoes – 600 mm

Standard counterweight – 2450 kg

Blade down

	1.5 m		3.0 m		4.5 m		6.0 m		7.5 m				
													m
6.0 m					*2700	*2700					*2430	*2430	5.19
4.5 m					*3480	*3480	*2870	2450			*2230	*2230	6.22
3.0 m					*5830	*5830	*4230	3750	*3630	2390			6.77
1.5 m					*6460	6340	*5180	3500	*4020	2300			6.95
0 m					*5600	*5600	*5830	3330	*4320	2220			6.8
-1.5 m	*4920	*4920	*5800	*5800	*5910	3270	*4260	2190					6.29
-3.0 m	*5350	*5350	*6760	6150	*5220	3320							5.33















312D L

Medium stick – 2500 mm

Shoes – 600 mm

Standard counterweight – 2450 kg

Blade down

	1.5 m		3.0 m		4.5 m		6.0 m		7.5 m				
													m
6.0 m													5.69
4.5 m					*3130	*3130	*3030	2500			*1830	*1830	6.64
3.0 m					*5100	*5100	*3920	3820	*3430	2430			7.15
1.5 m					*7770	6550	*4940	3570	*3870	2330			7.33
0 m					*5940	*5940	*5720	3380	*4250	2240			7.19
-1.5 m	*4490	*4490	*5930	*5930	*5970	3290	*4340	2190					6.71
-3.0 m	*5270	*5270	*6650	6140	*5530	3300							5.81
-4.5 m			*5870	*5870									















312D L

Long stick – 3000 mm

Shoes – 600 mm

Standard counterweight – 2450 kg

Blade down

	1.5 m		3.0 m		4.5 m		6.0 m		7.5 m				
													m
7.5 m													4.77
6.0 m							*2290	*2290			*1730	*1730	6.25
4.5 m							*2770	2530			*1620	*1620	7.12
3.0 m					*3430	*3430	*3110	2450	*1990	1670	*1620	*1620	7.61
1.5 m					*6860	6720	*4510	3610	*3610	2330	*2650	1620	7.77
0 m					*6650	6170	*5440	3370	*4070	2220	*2520	1580	7.64
-1.5 m	*4140	*4140	*6220	5990	*5880	3240	*4290	2150			*2230	1660	7.19
-3.0 m	*5270	*5270	*6670	6010	*5700	3220	*4030	2150			*2960	1990	6.37
-4.5 m			*6870	6190	*4470	3330					*3790	2910	4.97















312D L

Short stick – 2100 mm

Shoes – 600 mm

Heavy counterweight – 2650 kg

No Blade

	1.5 m		3.0 m		4.5 m		6.0 m		7.5 m				
													m
6.0 m					*3570	*3570					*2870	*2870	5.45
4.5 m					*3850	*3850	*3690	2590			*2590	2280	6.47
3.0 m					*4780	3850	3860	2520			*2540	1980	7.01
1.5 m					5760	3590	3740	2420			*2620	1870	7.18
0 m					5570	3430	3650	2340			*2880	1900	7.01
-1.5 m			*8290	6180	5530	3390	3630	2320			3280	2110	6.48
-3.0 m			*8200	6310	*5580	3450					*4130	2690	5.47



Load Point Height



Load Radius Over Front



Load Radius Over Side



Load at Maximum Reach

* Limited by hydraulic rather than tipping load.













The above loads are in compliance with hydraulic excavator lift capacity ratings standard ISO 10567, they do not exceed 87% of hydraulic lifting capacity or 75% of tipping capacity. Weight of all lifting accessories must be deducted from the above lifting capacities.

Lift Capacities with Reach Boom

All weights are in kg. Calculations are made without bucket, but with CW20 Quick Coupler.













312D L

Medium stick – 2500 mm
Shoes – 600 mm
Heavy counterweight – 2650 kg
No Blade

	1.5 m		3.0 m		4.5 m		6.0 m		7.5 m				
												m	
7.5 m											*2920	*2920	4.25
6.0 m											*2320	*2320	5.94
4.5 m					*3480	*3480	*3410	2640			*2130	2100	6.88
3.0 m			*6230	*6230	*4440	3920	*3770	2560			*2100	1850	7.38
1.5 m					*5620	3660	3780	2450	*2520	1770	*2170	1750	7.55
0 m			*4770	*4770	5630	3480	3680	2360			*2370	1780	7.39
-1.5 m	*4120	*4120	*7760	6190	5550	3410	3630	2320			*2780	1950	6.89
-3.0 m	*7620	*7620	*8890	6290	5580	3440					*3700	2390	5.95













312D L

Long stick – 3000 mm
Shoes – 600 mm
Heavy counterweight – 2650 kg
No Blade

	1.5 m		3.0 m		4.5 m		6.0 m		7.5 m				
												m	
7.5 m											*2400	*2400	5.02
6.0 m							*2990	2690			*2020	*2020	6.5
4.5 m							*3030	2670			*1890	1890	7.36
3.0 m					*3910	*3910	*3440	2580	2760	1810	*1880	1680	7.84
1.5 m					*5170	3700	3790	2450	2710	1760	*1950	1590	7.99
0 m			*5540	*5540	5630	3470	3660	2340	2650	1710	*2120	1610	7.84
-1.5 m	*3820	*3820	*7410	6100	5500	3360	3590	2280			*2470	1740	7.37
-3.0 m	*6560	*6560	*9460	6160	5500	3360	3600	2280			*3180	2070	6.51
-4.5 m			*7200	6360	*4670	3480					*3790	3000	5.05













312D L

Short stick – 2100 mm
Shoes – 600 mm
Heavy counterweight – 2650 kg
Blade up

	1.5 m		3.0 m		4.5 m		6.0 m		7.5 m				
												m	
6.0 m					*3570	*3570					*2870	*2870	5.45
4.5 m					*3850	*3850	*3690	2710			*2590	2390	6.47
3.0 m					*4780	4020	3830	2640			*2540	2080	7.01
1.5 m					5720	3760	3720	2540			*2620	1960	7.18
0 m					5540	3600	3630	2460			*2880	2000	7.01
-1.5 m			*8290	6480	5490	3560	3610	2430			3260	2220	6.48
-3.0 m			*8200	6610	5560	3620					*4130	2820	5.47

312D L

Medium stick – 2500 mm
Shoes – 600 mm
Heavy counterweight – 2650 kg
Blade up

	1.5 m		3.0 m		4.5 m		6.0 m		7.5 m				
												m	
7.5 m											*2920	*2920	4.25
6.0 m											*2320	*2320	5.94
4.5 m					*3480	*3480	*3410	2760			*2130	*2130	6.88
3.0 m			*6230	*6230	*4440	4090	*3770	2680			*2100	1940	7.38
1.5 m					*5620	3830	3750	2570	*2520	1860	*2170	1840	7.55
0 m			*4770	*4770	5590	3650	3650	2480			*2370	1870	7.39
-1.5 m	*4120	*4120	*7760	6490	5510	3580	3610	2440			*2780	2050	6.89
-3.0 m	*7620	*7620	*8890	6590	5550	3610					*3700	2510	5.95

312D/312D L Hydraulic Excavator Specifications

Lift Capacities with Reach Boom

All weights are in kg. Calculations are made without bucket, but with CW20 Quick Coupler.

312D L

Long stick – 3000 mm
Shoes – 600 mm
Heavy counterweight – 2650 kg
Blade up

Load Point Height	1.5 m		3.0 m		4.5 m		6.0 m		7.5 m		Load at Maximum Reach		m
	Load Radius Over Front	Load Radius Over Side	Load Radius Over Front	Load Radius Over Side	Load Radius Over Front	Load Radius Over Side	Load Radius Over Front	Load Radius Over Side	Load Radius Over Front	Load Radius Over Side	Load Radius Over Front	Load Radius Over Side	
7.5 m											*2400	*2400	5.02
6.0 m							*2990	2810			*2020	*2020	6.5
4.5 m							*3030	2790			*1890	*1890	7.36
3.0 m					*3910	*3910	*3440	2700	2740	1900	*1880	1760	7.84
1.5 m					*5170	3870	3760	2570	2690	1850	*1950	1680	7.99
0 m			*5540	*5540	5590	3640	3640	2460	2640	1800	*2120	1690	7.84
-1.5 m	*3820	*3820	*7410	6400	5470	3530	3570	2390			*2470	1830	7.37
-3.0 m	*6560	*6560	*9460	6460	5460	3530	3580	2400			*3180	2170	6.51
-4.5 m			*7200	6670	*4670	3650					*3790	3150	5.05

312D L

Short stick – 2100 mm
Shoes – 600 mm
Standard counterweight – 2450 kg
Blade down

Load Point Height	1.5 m		3.0 m		4.5 m		6.0 m		7.5 m		Load at Maximum Reach		m
	Load Radius Over Front	Load Radius Over Side	Load Radius Over Front	Load Radius Over Side	Load Radius Over Front	Load Radius Over Side	Load Radius Over Front	Load Radius Over Side	Load Radius Over Front	Load Radius Over Side	Load Radius Over Front	Load Radius Over Side	
6.0 m					*2700	*2700					*2430	*2430	5.19
4.5 m					*3480	*3480	*2870	2540			*2230	*2230	6.22
3.0 m			*5830	*5830	*4230	3870	*3630	2480			*2220	2030	6.77
1.5 m			*6460	*6460	*5180	3630	*4020	2380			*2340	1900	6.95
0 m			*5600	*5600	*5830	3450	*4320	2300			*2630	1930	6.8
-1.5 m	*4920	*4920	*5800	*5800	*5910	3390	*4260	2280			*3210	2140	6.29
-3.0 m	*5350	*5350	*6760	6370	*5220	3440					*4090	2750	5.33

312D L

Medium stick – 2500 mm
Shoes – 600 mm
Standard counterweight – 2450 kg
Blade down

Load Point Height	1.5 m		3.0 m		4.5 m		6.0 m		7.5 m		Load at Maximum Reach		m
	Load Radius Over Front	Load Radius Over Side	Load Radius Over Front	Load Radius Over Side	Load Radius Over Front	Load Radius Over Side	Load Radius Over Front	Load Radius Over Side	Load Radius Over Front	Load Radius Over Side	Load Radius Over Front	Load Radius Over Side	
6.0 m											*1970	*1970	5.69
4.5 m					*3130	*3130	*3030	2590			*1830	*1830	6.64
3.0 m			*5100	*5100	*3920	*3920	*3430	2520			*1820	*1820	7.15
1.5 m			*7770	6780	*4940	3700	*3870	2420			*1910	1770	7.33
0 m			*5940	*5940	*5720	3500	*4250	2330			*2130	1790	7.19
-1.5 m	*4490	*4490	*5930	*5930	*5970	3410	*4340	2280			*2550	1960	6.71
-3.0 m	*5270	*5270	*6650	6360	*5530	3430					*3510	2420	5.81
-4.5 m			*5870	*5870									

312D L

Long stick – 3000 mm
Shoes – 600 mm
Standard counterweight – 2450 kg
Blade down

Load Point Height	1.5 m		3.0 m		4.5 m		6.0 m		7.5 m		Load at Maximum Reach		m
	Load Radius Over Front	Load Radius Over Side	Load Radius Over Front	Load Radius Over Side	Load Radius Over Front	Load Radius Over Side	Load Radius Over Front	Load Radius Over Side	Load Radius Over Front	Load Radius Over Side	Load Radius Over Front	Load Radius Over Side	
7.5 m											*2040	*2040	4.77
6.0 m							*2290	*2290			*1730	*1730	6.25
4.5 m							*2770	2620			*1620	*1620	7.12
3.0 m					*3430	*3430	*3110	2540	*1990	1740	*1620	*1620	7.61
1.5 m			*6860	*6860	*4510	3730	*3610	2420	*2650	1690	*1700	1590	7.77
0 m			*6650	6390	*5440	3500	*4070	2300	*2520	1650	*1890	1600	7.64
-1.5 m	*4140	*4140	*6220	6210	*5880	3370	*4290	2240			*2230	1730	7.19
-3.0 m	*5270	*5270	*6670	6230	*5700	3350	*4030	2240			*2960	2070	6.37
-4.5 m			*6870	6410	*4470	3460					*3790	3020	4.97



Load Point Height



Load Radius Over Front



Load Radius Over Side



Load at Maximum Reach

* Limited by hydraulic rather than tipping load.

The above loads are in compliance with hydraulic excavator lift capacity ratings standard ISO 10567, they do not exceed 87% of hydraulic lifting capacity or 75% of tipping capacity. Weight of all lifting accessories must be deducted from the above lifting capacities.

312D/312D L Hydraulic Excavator Specifications

Lift Capacities with VA Boom

All weights are in kg. Calculations are made without bucket, but with CW20 Quick Coupler.

312D
Short stick – 2100 mm
Shoes – 600 mm
Standard counterweight – 2450 kg
No Blade

Stick Length	1.5 m		3.0 m		4.5 m		6.0 m		7.5 m		m	
7.5 m			*2780	*2780								
6.0 m			*2970	*2970	*2750	*2750				*2790	*2790	3.51
4.5 m			*5020	*5020	*4240	3770	*2960	2260		*2150	*2150	5.36
3.0 m			*7950	6820	5010	*3770	3160	2250		*1960	*1960	6.36
1.5 m	*5690	*5690	*8250	6630	*4930	3560	3070	2180		*1930	1700	6.9
0 m	*5520	*5520	*8500	6120	4780	3310	2970	2060		*2020	1580	7.08
-1.5 m	*5510	*5510	*8750	5810	4610	3150	2870	1970		*2240	1600	6.93
-3.0 m	*6550	*6550	*8250	5790	4480	3040				2580	1770	6.44
-4.5 m												

312D
Medium stick – 2500 mm
Shoes – 600 mm
Standard counterweight – 2450 kg
No Blade

Stick Length	1.5 m		3.0 m		4.5 m		6.0 m		7.5 m		m	
7.5 m										*2160	*2160	4.24
6.0 m					*2770	*2770				*1740	*1740	5.86
4.5 m			*3910	*3910	*4120	3820	*3110	2350		*1600	*1600	6.78
3.0 m			*7430	6880	5040	3780	3230	2330		*1570	1570	7.29
1.5 m	*7850	*7850	*8530	6650	4940	3650	3140	2250		*1640	1460	7.46
0 m	*5420	*5420	*8480	6280	4860	3380	3020	2120		*1800	1480	7.32
-1.5 m	*5550	*5550	*8840	5890	4640	3180	2910	2000		*2130	1620	6.86
-3.0 m	*6330	*6330	*8890	5800	4510	3060						
-4.5 m												

312D
Long stick – 3000 mm
Shoes – 600 mm
Standard counterweight – 2450 kg
No Blade

Stick Length	1.5 m		3.0 m		4.5 m		6.0 m		7.5 m		m		
7.5 m					*2530	*2530				*3180	*3180	1.92	
6.0 m					*2780	*2780	*2480	2360		*1840	*1840	4.99	
4.5 m					*3440	*3440	*3240	2410		*1550	*1550	6.42	
3.0 m			*4700	*4700	*4530	3770	3270	2390	2160	1520	*1440	*1440	7.28
1.5 m	*9780	*9780	*8590	6630	4920	3670	3190	2300	2120	1480	*1430	1410	7.75
0 m	*5980	*5980	*8380	6430	4850	3420	3060	2170	2070	1420	*1500	1320	7.91
-1.5 m	*5730	*5730	*8940	5940	4670	3200	2930	2020			*1640	1330	7.78
-3.0 m	*6270	*6270	9140	5780	4530	3070	2860	1950			*1920	1440	7.34
-4.5 m	*8070	*8070	*6430	5800							*2230	1730	6.53

312D
Short stick – 2100 mm
Shoes – 600 mm
Heavy counterweight – 2650 kg
No Blade

Stick Length	1.5 m		3.0 m		4.5 m		6.0 m		7.5 m		m	
7.5 m			*2780	*2780						*2790	*2790	3.51
6.0 m			*2970	*2970	*2750	*2750				*2150	*2150	5.36
4.5 m			*5020	*5020	*4240	*3870	*2960	2360		*1960	*1960	6.36
3.0 m			*7950	7000	5150	3870	3270	2350		*1930	1780	6.9
1.5 m	*5690	*5690	*8260	6780	5060	3690	3190	2270		*2020	1670	7.08
0 m	*5520	*5520	*8500	6360	4950	3450	3080	2160		*2240	1690	6.93
-1.5 m	*5510	*5510	*8750	6080	4790	3300	3000	2080		*2680	1880	6.44
-3.0 m	*6550	*6550	*8300	6070	*4550	3200						
-4.5 m												

312D/312D L Hydraulic Excavator Specifications

Lift Capacities with VA Boom

All weights are in kg. Calculations are made without bucket, but with CW20 Quick Coupler.

312D

Medium stick – 2500 mm
Shoes – 600 mm
Heavy counterweight – 2650 kg
No Blade

Reach (m)	1.5 m		3.0 m		4.5 m		6.0 m		7.5 m		Load at Maximum Reach		m
	Front	Side	Front	Side	Front	Side	Front	Side	Front	Side	Front	Side	
7.5 m											*2160	*2160	4.24
6.0 m					*2770	*2770					*1740	*1740	5.86
4.5 m			*3910	*3910	*4120	3930	*3110	2440			*1600	*1600	6.78
3.0 m			*7430	7070	*5190	3880	3330	2420			*1570	*1570	7.29
1.5 m	*7850	*7850	*8540	*6860	5080	3780	3250	2330			*1640	1550	7.46
0 m	*5420	*5420	*8480	6520	4990	3510	3140	2220			*1800	1560	7.32
-1.5 m	*5550	*5550	*8840	6150	4820	3330	3030	2110			*2130	1710	6.86
-3.0 m	*6330	*6330	*8930	6080	4700	3220							
-4.5 m													

312D

Long stick – 3000 mm
Shoes – 600 mm
Heavy counterweight – 2650 kg
No Blade

Reach (m)	1.5 m		3.0 m		4.5 m		6.0 m		7.5 m		Load at Maximum Reach		m
	Front	Side	Front	Side	Front	Side	Front	Side	Front	Side	Front	Side	
7.5 m					*2530	*2530					*3180	*3180	1.92
6.0 m					*2780	*2780	*2480	2450			*1840	*1840	4.99
4.5 m					*3440	*3440	*3240	2490			*1550	*1550	6.42
3.0 m			*4700	*4700	*4530	3880	3370	2470	2240	1580	*1440	*1440	7.28
1.5 m	*9780	*9780	*8590	6850	5050	3790	3300	2380	2200	1550	*1430	*1430	7.75
0 m	*5980	*5980	*8380	6660	4980	3550	3160	2250	2140	1490	*1500	1380	7.91
-1.5 m	*5730	*5730	*8940	6170	4820	3330	3030	2110			*1640	1390	7.78
-3.0 m	*6270	*6270	*9190	6000	4680	3200	2960	2040			*1920	1510	7.34
-4.5 m	*8070	*8070	*6430	6020							*2230	1810	6.53

312D L

Short stick – 2100 mm
Shoes – 600 mm
Standard counterweight – 2450 kg
No Blade

Reach (m)	1.5 m		3.0 m		4.5 m		6.0 m		7.5 m		Load at Maximum Reach		m
	Front	Side	Front	Side	Front	Side	Front	Side	Front	Side	Front	Side	
7.5 m			*2780	*2780							*2790	*2790	3.51
6.0 m			*2970	*2970	*2750	*2750					*2150	*2150	5.36
4.5 m			*5020	*5020	*4240	3820	*2960	2320			*1960	*1960	6.36
3.0 m			*7950	6900	*5420	3820	3620	2310			*1930	1750	6.9
1.5 m	*5690	*5690	*8260	6750	5530	3640	3540	2230			*2020	1630	7.08
0 m	*5520	*5520	*8500	6260	5530	3390	3430	2120			*2240	1660	6.93
-1.5 m	*5510	*5510	*8750	5980	5390	3250	3350	2050			*2680	1840	6.44
-3.0 m	*6550	*6550	*8300	5970	*4550	3140							
-4.5 m													

312D L

Medium stick – 2500 mm
Shoes – 600 mm
Standard counterweight – 2450 kg
No Blade

Reach (m)	1.5 m		3.0 m		4.5 m		6.0 m		7.5 m		Load at Maximum Reach		m
	Front	Side	Front	Side	Front	Side	Front	Side	Front	Side	Front	Side	
7.5 m											2160	2160	4.24
6.0 m					*2770	*2770					1740	1740	5.86
4.5 m			*3910	*3910	4120	*3880	*3110	2400			1600	1600	6.78
3.0 m			*7430	7010	5190	3840	3680	2380			1570	1570	7.29
1.5 m	*7850	*7850	*8540	6780	5560	3720	3600	2300			1640	1520	7.46
0 m	*5420	*5420	*8480	6420	5520	3460	3480	2180			1800	1530	7.32
-1.5 m	*5550	*5550	*8840	6050	5430	3280	3370	2070			2130	1680	6.86
-3.0 m	*6330	*6330	*8930	5980	5300	3170							
-4.5 m													



Load Point Height



Load Radius Over Front



Load Radius Over Side



Load at Maximum Reach

* Limited by hydraulic rather than tipping load.

The above loads are in compliance with hydraulic excavator lift capacity ratings standard ISO 10567, they do not exceed 87% of hydraulic lifting capacity or 75% of tipping capacity. Weight of all lifting accessories must be deducted from the above lifting capacities.

312D/312D L Hydraulic Excavator Specifications

Lift Capacities with VA Boom

All weights are in kg. Calculations are made without bucket, but with CW20 Quick Coupler.













312D L

Long stick – 3000 mm

Shoes – 600 mm

Standard counterweight – 2450 kg

No Blade

	1.5 m		3.0 m		4.5 m		6.0 m		7.5 m				m
													
7.5 m					*2530	*2530					*3180	*3180	1.92
6.0 m					*2780	*2780	*2480	2400			*1840	*1840	4.99
4.5 m					*3440	*3440	*3240	2460			*1550	*1550	6.42
3.0 m			*4700	*4700	*4530	3850	3670	2440	*2270	1550	*1440	*1440	7.28
1.5 m	*9780	*9780	*8570	6760	5530	3740	3620	2350	2430	1510	*1430	*1430	7.75
0 m	*5980	*5980	*8380	6550	5450	3490	3500	2210	2370	1440	*1500	1340	7.91
-1.5 m	*5730	*5730	*8920	6040	5410	3250	3360	2060			*1640	1350	7.78
-3.0 m	*6270	*6270	*9150	5860	5250	3120	3290	1980			*1920	1460	7.34
-4.5 m	*8070	*8070	*6370	5870							*2200	1750	6.53













312D L

Short stick – 2100 mm

Shoes – 600 mm

Standard counterweight – 2450 kg

Blade down

	1.5 m		3.0 m		4.5 m		6.0 m		7.5 m				m
													
7.5 m			*2780	*2780							*2790	*2790	3.51
6.0 m			*2970	*2970	*2750	*2750					*2150	*2150	5.36
4.5 m			*5020	*5020	*4240	3940	*2960	2410			*1960	*1960	6.36
3.0 m			*7950	7080	*5420	3930	3730	2400			*1930	1830	6.9
1.5 m	*5690	*5690	*8260	6910	*5660	3760	3650	2320			*2020	1710	7.08
0 m	*5520	*5520	*8500	6490	5650	3520	3540	2210			*2240	1730	6.93
-1.5 m	*5510	*5510	*8750	6210	5540	3370	3460	2130			*2680	1920	6.44
-3.0 m	*6550	*6550	*8300	6190	*4550	3270							
-4.5 m													













312D L

Medium stick – 2500 mm

Shoes – 600 mm

Standard counterweight – 2450 kg

Blade down

	1.5 m		3.0 m		4.5 m		6.0 m		7.5 m				m
													
7.5 m											*2160	*2160	4.24
6.0 m					*2770	*2770					*1740	*1740	5.86
4.5 m			*3910	*3910	*4120	3990	*3110	2480			*1600	*1600	6.78
3.0 m			*7430	7190	*5190	3950	3780	2470			*1570	*1570	7.29
1.5 m	*7850	*7850	*8540	6940	*5690	3820	3710	2380			*1640	1590	7.46
0 m	*5420	*5420	*8480	6650	5650	3580	3590	2270			*1800	1600	7.32
-1.5 m	*5550	*5550	*8840	6280	5600	3400	3490	2160			*2130	1760	6.86
-3.0 m	*6330	*6330	*8930	6210	*5350	3290							
-4.5 m													













312D L

Long stick – 3000 mm

Shoes – 600 mm

Standard counterweight – 2450 kg

Blade down

	1.5 m		3.0 m		4.5 m		6.0 m		7.5 m				m
													
7.5 m					*2530	*2530					*3180	*3180	1.92
6.0 m					*2780	*2780	*2480	*2480			*1840	*1840	4.99
4.5 m					*3440	*3440	*3240	2540			*1550	*1550	6.42
3.0 m			*4700	*4700	*4530	3950	3780	2520	*2270	1620	*1440	*1440	7.28
1.5 m	*9780	*9780	*8590	6930	*5560	*3860	3720	2430	2530	1580	*1430	*1430	7.75
0 m	*5980	*5980	*8380	6780	5580	3620	3620	2310	2470	1530	*1500	1420	7.91
-1.5 m	*5730	*5730	*8940	6300	5600	3400	3490	2160			*1640	1430	7.78
-3.0 m	*6270	*6270	*9190	6130	5450	3270	*3330	2090			*1920	1550	7.34
-4.5 m	*8070	*8070	*6430	6150							*2230	1850	6.53

312D/312D L Hydraulic Excavator Specifications

Lift Capacities with VA Boom

All weights are in kg. Calculations are made without bucket, but with CW20 Quick Coupler.

312D L

Short stick – 2100 mm

Shoes – 600 mm

Heavy counterweight – 2650 kg

No Blade

Load Point Height	1.5 m		3.0 m		4.5 m		6.0 m		7.5 m		Load at Maximum Reach	m	
	Load Radius Over Front	Load Radius Over Side	Load Radius Over Front	Load Radius Over Side	Load Radius Over Front	Load Radius Over Side	Load Radius Over Front	Load Radius Over Side	Load Radius Over Front	Load Radius Over Side			
7.5 m			*2780	*2780							*2790	*2790	3.51
6.0 m			*2970	*2970	*2750	*2750					*2150	*2150	5.36
4.5 m			*5020	*5020	*4240	3970	*2960	2440			*1960	*1960	6.36
3.0 m			*7950	7160	*5420	3970	*4170	2430			*1930	1850	6.9
1.5 m	*5690	*5690	*8260	6980	*5880	3810	*4340	2350			*2020	1730	7.08
0 m	*5520	*5520	*8500	6560	*5920	3560	*4340	2240			*2240	1750	6.93
-1.5 m	*5510	*5510	*8750	6280	*6010	3420	*3760	2160			*2680	1950	6.44
-3.0 m	*6550	*6550	*8300	6270	*4550	3310							
-4.5 m													

312D L

Medium stick – 2500 mm

Shoes – 600 mm

Heavy counterweight – 2650 kg

No Blade

Load Point Height	1.5 m		3.0 m		4.5 m		6.0 m		7.5 m		Load at Maximum Reach	m	
	Load Radius Over Front	Load Radius Over Side	Load Radius Over Front	Load Radius Over Side	Load Radius Over Front	Load Radius Over Side	Load Radius Over Front	Load Radius Over Side	Load Radius Over Front	Load Radius Over Side			
7.5 m											*2160	*2160	4.24
6.0 m					*2770	*2770					*1740	*1740	5.86
4.5 m			*3910	*3910	*4120	4010	*3110	2510			*1600	*1600	6.78
3.0 m			*7430	*7240	*5190	3970	*4020	*2500			*1570	*1570	7.29
1.5 m	*7850	*7850	*8540	7010	*5800	3870	*4300	2410			*1640	1610	7.46
0 m	*5420	*5420	*8480	6720	*5940	3630	*4330	2300			*1800	1630	7.32
-1.5 m	*5550	*5550	*8840	6360	*5990	3450	*4140	2190			*2130	1780	6.86
-3.0 m	*6330	*6330	*8930	6280	*5350	3340							
-4.5 m													

312D L

Long stick – 3000 mm

Shoes – 600 mm

Heavy counterweight – 2650 kg

No Blade

Load Point Height	1.5 m		3.0 m		4.5 m		6.0 m		7.5 m		Load at Maximum Reach	m	
	Load Radius Over Front	Load Radius Over Side	Load Radius Over Front	Load Radius Over Side	Load Radius Over Front	Load Radius Over Side	Load Radius Over Front	Load Radius Over Side	Load Radius Over Front	Load Radius Over Side			
9.0 m											*3180	*3180	1.92
7.5 m					*2530	*2530					*1840	*1840	4.99
6.0 m					*2780	*2780	*2480	*2480			*1550	*1550	6.42
4.5 m					*3440	*3440	*3240	2570			*1440	*1440	7.28
3.0 m			*4700	*4700	*4530	3970	*3780	2550	*2270	1650	*1430	*1430	7.75
1.5 m	*9780	*9780	*8590	7000	*5560	3880	*4130	2460	*2900	1600	*1500	1440	7.91
0 m	*5980	*5980	*8380	6860	*5880	3670	*4270	2330	*2880	1550	*1640	1450	7.78
-1.5 m	*5730	*5730	*8940	6370	*5880	3440	*4270	2190			*1920	1570	7.34
-3.0 m	*6270	*6270	*9190	6210	*5800	3310	*3330	2120			*2230	1880	6.53
-4.5 m	*8070	*8070	*6430	6230									



Load Point Height



Load Radius Over Front



Load Radius Over Side



Load at Maximum Reach

* Limited by hydraulic rather than tipping load.

The above loads are in compliance with hydraulic excavator lift capacity ratings standard ISO 10567, they do not exceed 87% of hydraulic lifting capacity or 75% of tipping capacity. Weight of all lifting accessories must be deducted from the above lifting capacities.

312D/312D L Hydraulic Excavator Specifications

Lift Capacities with VA Boom

All weights are in kg. Calculations are made without bucket, but with CW20 Quick Coupler.

312D L

Short stick – 2100 mm

Shoes – 600 mm

Heavy counterweight – 2650 kg

Blade down

Stick length (m)	1.5 m		3.0 m		4.5 m		6.0 m		7.5 m		VA Boom		m
	Quick Coupler	Quick Coupler	Quick Coupler	Quick Coupler	Quick Coupler	Quick Coupler	Quick Coupler	Quick Coupler	Quick Coupler	Quick Coupler	Quick Coupler	Quick Coupler	
7.5 m			*2780	*2780							*2790	*2790	3.51
6.0 m			*2970	*2970	*2750	*2750					*2150	*2150	5.36
4.5 m			*5020	*5020	*4240	4080	*2960	2520			*1960	*1960	6.36
3.0 m			*7950	7340	*5420	4080	*4170	2510			*1930	1930	6.9
1.5 m	*5690	*5690	*8260	7140	*5880	3930	*4340	2440			*2020	1800	7.08
0 m	*5520	*5520	*8500	6790	*5920	3690	*4340	2330			*2240	1830	6.93
-1.5 m	*5510	*5510	*8750	6510	*6010	3540	*3760	2250			*2680	2030	6.44
-3.0 m	*6550	*6550	*8300	6500	*4550	3440							
-4.5 m													

312D L

Medium stick – 2500 mm

Shoes – 600 mm

Heavy counterweight – 2650 kg

Blade down

Stick length (m)	1.5 m		3.0 m		4.5 m		6.0 m		7.5 m		VA Boom		m
	Quick Coupler	Quick Coupler	Quick Coupler	Quick Coupler	Quick Coupler	Quick Coupler	Quick Coupler	Quick Coupler	Quick Coupler	Quick Coupler	Quick Coupler	Quick Coupler	
7.5 m											*2160	*2160	4.24
6.0 m					*2770	*2770					*1740	*1740	5.86
4.5 m			*3910	*3910	*4120	*4120	*3110	2600			*1600	*1600	6.78
3.0 m			*7430	*7430	*5190	*4090	*4020	2580			*1570	*1570	7.29
1.5 m	*7850	*7850	*8540	7180	*5800	3990	*4300	2500			*1640	*1640	7.46
0 m	*5420	*5420	*8480	6950	*5940	3750	*4330	2390			*1800	1700	7.32
-1.5 m	*5550	*5550	*8840	6580	*5990	3570	*4140	2280			*2130	1860	6.86
-3.0 m	*6330	*6330	*8930	6510	*5350	3460							
-4.5 m													

312D L

Long stick – 3000 mm

Shoes – 600 mm

Heavy counterweight – 2650 kg

Blade down

Stick length (m)	1.5 m		3.0 m		4.5 m		6.0 m		7.5 m		VA Boom		m
	Quick Coupler	Quick Coupler	Quick Coupler	Quick Coupler	Quick Coupler	Quick Coupler	Quick Coupler	Quick Coupler	Quick Coupler	Quick Coupler	Quick Coupler	Quick Coupler	
7.5 m					*2530	*2530					*3180	*3180	1.92
6.0 m					*2780	*2780	*2480	*2480			*1840	*1840	4.99
4.5 m					*3440	*3440	*3240	2660			*1550	*1550	6.42
3.0 m			*4700	*4700	*4530	*4090	*3780	2640	*2270	1710	*1440	*1440	7.28
1.5 m	*9780	*9780	*8590	7170	*5560	*4000	*4130	2550	*2900	1670	*1430	*1430	7.75
0 m	*5980	*5980	*8380	7080	*5880	3790	*4270	2410	*2880	1620	*1500	*1500	7.91
-1.5 m	*5730	*5730	*8940	6600	*5880	3570	*4270	2280			*1640	1510	7.78
-3.0 m	*6270	*6270	*9190	6430	*5800	3440	*3330	2210			*1920	1640	7.34
-4.5 m	*8070	*8070	*6430	*6430							*2230	1960	6.53

312D/312D L Standard Equipment

Standard equipment may vary. Consult your Caterpillar dealer for details

Electrical

- 24 V electric starting
- 50 A alternator
- Cat battery
- Circuit breaker
- Warning horn
- Working light mounted on storage box

Engine

- 2300 m altitude capability
- Additional 10 micron fuel filter
- Cat C4.2 ACERT Diesel Engine with 24 V electric starting and air-intake heater
- Caterpillar extended life coolant
- Economy mode
- One touch low idle with Automatic Engine Speed Control
- Remote engine oil filter
- Secondary engine shutoff switch
- Stage IIIA emission package for EU territories
- Two 2-micron fuel filters
- Water separator in fuel line

Operator Station

- Adjustable armrests
- Air conditioner
- Ashtray and 24 V cigar lighter
- Beverage holder
- Bolt-on FOGS installation capability
- Coat hook
- Flexible antenna
- High Back Seat
- Interior lighting
- Literature compartment
- Positive filtered ventilation

- Rear window, emergency exit
- Retractable seat belt
- Seat integrated control joysticks
- Sliding upper door window
- Stationary skylight (polycarbonate)
- Storage compartment suitable for lunch box and utility space for magazines
- Tool control (to preset up to 10 hydraulic work tools configurations)
- Two travel control pedals with removable hand levers
- Washable floor mat
- Windshield wiper (parallel type) and washer

Monitor

- Full graphic and full color display with language capability
- Full time clock
- Start up level check for hydraulic oil, engine oil and engine coolant
- Warning information, filter and fluid change information
- Working hour information

Undercarriage/Structure

- Automatic travel parking brakes
- Grease lubricated tracks
- Heavy duty idler tension spring
- Hydraulic track adjusters
- Idler and center track guiding guards
- Steps - four
- Towing eye on base frame
- Two speed travel with automatic shift change

Other Standard Equipment

- “On Demand Power Supply” (Regulation of engine rpms according to hydraulic demands)
- 2450 kg counterweight
- Automatic swing parking brake
- Doors and cab locks with Caterpillar one key security system
- Steel firewall between engine and main pump
- Boom and stick drift reducing valves
- Boom and stick regeneration circuits
- Boom lowering device for backup
- Cat branded XT hoses and reusable couplings
- Cab handrail
- Cat Data Link and capability to use ET (Electronic Tool Technician)
- EU sound package for EU territories
- High performance hydraulic oil, capsule filter
- Mirrors, rear view (frame right, cab left)
- One auxiliary hydraulic valve
- Product Link ready
- Radial seal air filters with double element
- Reverse swing damping valve
- Sound and vibration suppression system
- Straight line travel
- S•O•S quick sampling valves for engine oil, hydraulic oil and coolant

Optional equipment may vary. Consult your Caterpillar dealer for details.

Front Linkage

Booms

- One-piece 4650 mm
- Variable Angle

Bucket linkage

Sticks

- Short 2100 mm
- Medium 2500 mm
- Long 3000 mm

Quick couplers

Tear drop pin conversion

Undercarriage

Tracks for standard undercarriage

- 500 mm Triple Grouser
- 700 mm Triple Grouser

For long undercarriage

- 500 mm Triple Grouser
- 600 mm Triple Grouser
- 700 mm Triple Grouser

Blades

- 2500 mm
- 2700 mm

Guards

Bottom guard, heavy duty

Swivel guard

Track guiding guards, full length for long undercarriage

Operator Compartment

Cover for lunch box

Two available types of joystick :

- 1) Joystick with four on/off buttons, or
- 2) Thumb wheel modulation joystick

Radio

Rain protector for front windshield

Seats

- High-back seat, mechanical suspension
- High-back seat, air suspension, heater

Sunshade

Windshield

- One-piece highly resistant
- 70/30 split

Hydraulics

Auxiliary Combined Action Circuit

Auxiliary Single Action circuit

Boom auxiliary lines

Boom medium pressure lines

Boom quick coupler lines

Medium pressure system

Quick disconnect Medium Pressure

Quick Coupler Control Circuit

Stick auxiliary lines

Stick medium pressure lines

Stick quick coupler lines

Miscellaneous Options

Boom lowering control device (with Over Load Warning Device)

Heavy counterweight, 2650 kg, with lifting eye

High Ambient Cooling package

Starting kit, cold weather (-25 °C)

Stick lowering control device

Water separator level indicator

Working light, boom, right side

2 Working lights, cab mounted

Travel alarm

312D/312D L Hydraulic Excavator

For more complete information on Cat products, dealer services, and industry solutions, visit us on the web at www.cat.com

HEHH3745 (03/2008) hr

Materials and specifications are subject to change without notice. Featured machines in photos may include additional equipment. See your Caterpillar dealer for available options.

© 2008 Caterpillar -- All rights reserved

CAT, CATERPILLAR, their respective logos, "Caterpillar Yellow" and the POWER EDGE trade dress as well as corporate and product identity used herein, are trademarks of Caterpillar and may not be used without permission.

CATERPILLAR[®]