



328D LCR

Hydraulic Excavator



CAT[®]

Cat[®] C7 Diesel Engine with ACERT[™] Technology

Net Power (ISO 9249) at 1800 rpm	140 kW/190 hp
Operating Weight	35 400 kg
Maximum Travel Speed	4.2 km/h
Maximum Reach at Ground Level	10 560 mm
Maximum Digging Depth	6920 mm
Tail Swing Radius	1900 mm

328D LCR Hydraulic Excavator

Offers a compact radius and improved performance, versatility and styling.

C7 Engine with ACERT™ Technology

ACERT Technology works at the point of combustion to optimize engine performance and provide low exhaust emissions to meet EU Stage IIIA emission regulations, with exceptional performance capabilities and proven reliability. **pg. 4**

Hydraulics

The hydraulic system has been designed to provide reliability and outstanding controllability. An optional Tool Control System provides enhanced flexibility. **pg. 5**

Operator Station

Provides maximum space, wider visibility and easy access to switches. The monitor is a full-color graphical display that allows the operator to understand the machine information easily. Overall, the new cab provides a comfortable environment for the operator. **pg. 6**

Boom, Stick and Linkage

A reach boom and a long stick is available to suit a variety of application conditions. **pg. 8**

Structures

Caterpillar® design and manufacturing techniques assure outstanding durability and service life from these important components. **pg. 8**

Work Tools and GET

A variety of work tools, including buckets, couplers, hammers, crushers, pulverizers, multiprocessors, shears and grapples are available. **pg. 10**

Service and Maintenance

Fast, easy service has been designed in with extended service intervals, advanced filtration, convenient filter access and user-friendly electronic diagnostics for increased productivity and reduced maintenance costs. **pg. 9**

Complete Customer Support

Your Cat dealer offers a wide range of services that can be set up under a customer support agreement when you purchase your equipment. The dealer will help you choose a plan that can cover everything from machine configuration to eventual replacement. **pg. 9**



Compact Radius

The 328D LCR has been designed to rotate with a minimal amount of counterweight hanging over the tracks, which allows it to work in tight, confined areas.



Space Restriction. The increasing need to work within space-restricted areas has created a demand for larger excavators that can also work within tighter quarters and provide greater productivity. The newest addition to this lineup of Compact Radius (CR) excavators is the 328D LCR.

Productivity. Even though the 328D LCR has been designed for use in specific applications that require high maneuverability in confined spaces, it still maintains the ability to accomplish tasks in a variety of applications where space is not a factor.

Swing Radius. The Caterpillar 328D LCR has a tail swing radius of 1900 mm as compared to 3080 mm for the standard Caterpillar 325D L. This reduction of tail swing may allow for swing operation with greater confidence knowing that the tail of the machine only has a minimal amount of overhang.

Lift and Stability. The boom on the 328D LCR has been moved more towards the center of the machine, this results in overall greater lift capacity over the front as compared to the standard 325D L. In addition to the repositioning of the boom, the Cat 328D LCR utilizes the undercarriage of the 330D L, which allows for an extremely stable operating platform.

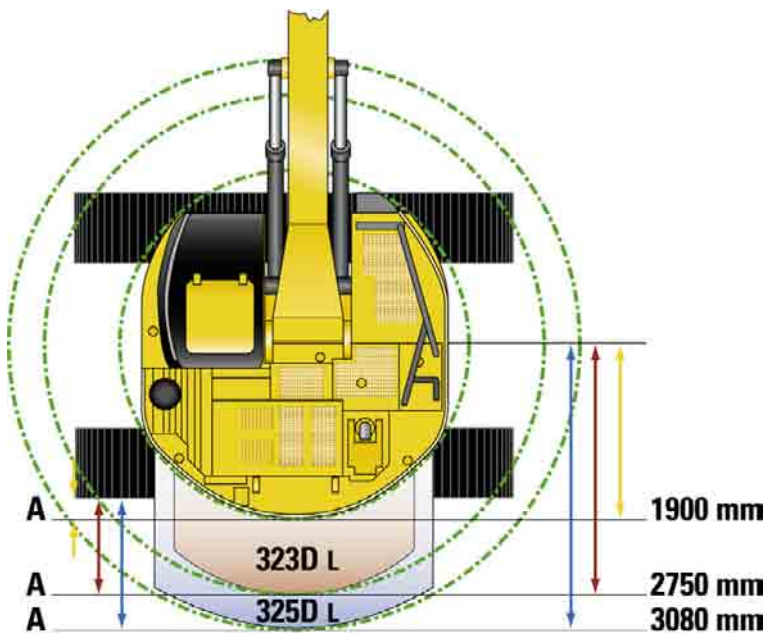

	328D LCR	323D L	325D L
Tail swing radius (mm)	1900	2750	3080
A Overhang (mm)			
with 600 mm shoes	305	1235	1485
with 850 mm shoes	180	1110	1360



328D LCR versus 325D L. Compare minimum front swing radius and tail swing radius:

	328D LCR	325D L
Tail swing radius (mm)	1900	3080
Minimum front swing radius (mm)	3400	4140

Engine

Built for power reliability, economy and low emissions.

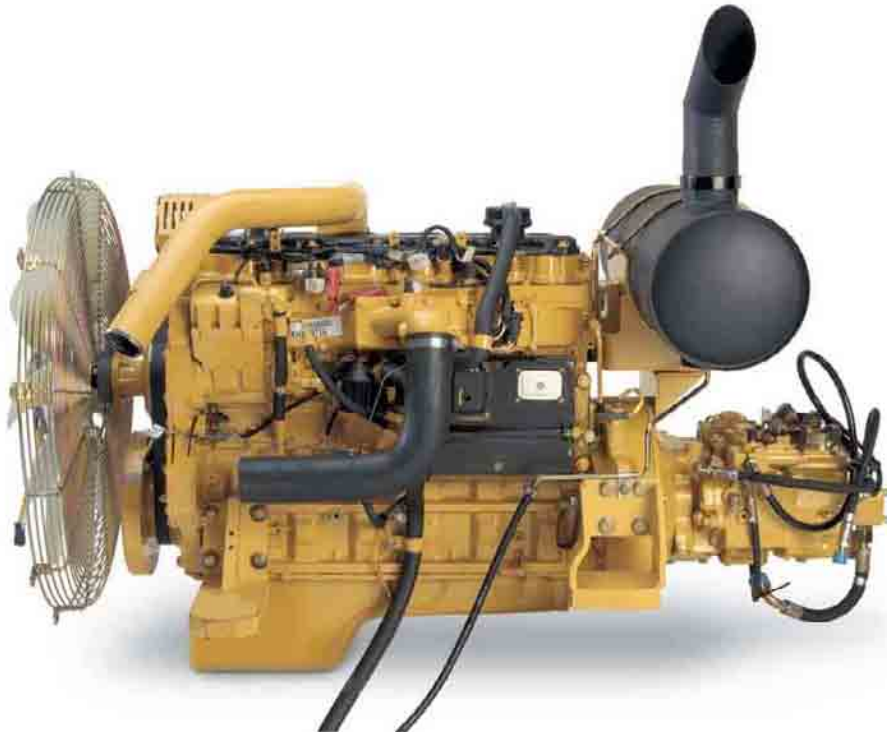

Cat C7 ACERT. The Cat C7 with ACERT Technology introduces a series of evolutionary, incremental improvements that provide breakthrough engine technology. The building blocks of ACERT Technology are fuel delivery, air management and electronic control. ACERT Technology optimizes engine performance while meeting EU Stage IIIA engine emission regulations.

Performance. The 328D LCR, equipped with the C7 engine with ACERT Technology, provides 8% more horsepower as compared to the 3126B ATAAC HEUI in the 325C LCR.

Automatic Engine Speed Control. The two-stage, one-touch control maximizes fuel efficiency and reduces sound levels.

ADEM™ A4 Engine Controller. The ADEM A4 electronic control module manages fuel delivery to get the best performance per liter (gallon) of fuel used. The engine management system provides flexible fuel mapping, allowing the engine to respond quickly to varying application needs. It tracks engine and machine conditions while keeping the engine operating at peak efficiency.

Electronic Control Module.

The Electronic Control Module (ECM) works as the “brain” of the engine’s control system, responding quickly to operating variables to maximize engine efficiency. Fully integrated with sensors in the engine’s fuel, air, coolant, and exhaust systems, the ECM stores and relays information on conditions such as rpm, fuel consumption, and diagnostic information.

Fuel Delivery. The Cat C7 features electronic controls that govern the fuel injection system. Multiple injection fuel delivery involves a high degree of precision. Precisely shaping the combustion cycle lowers combustion chamber temperatures, generating fewer emissions and optimizing fuel combustion. This translates into more work output for your fuel cost.

Cooling System. The cooling fan is directly driven from the engine. An electrically controlled viscous clutch fan is utilized to reduce fan noise. The optimum fan speed is calculated based on the target engine speed, coolant temperature, hydraulic oil temperature and actual fan speed. The 328D LCR incorporates side by side cooling, allowing easy access to keep the cooling cores free of debris.

Air Cleaner. The radial seal air filter features a double-layered filter core for more efficient filtration and is located in a compartment behind the cab. A warning is displayed on the monitor when dust accumulates above a preset level.

Noise Reduction Technologies.

The engine mounts are rubber-isolating mounts matched with the engine package. Further noise reduction has been achieved through design changes to the isolated top cover, oil pan, multiple injection strategy, insulated timing cover, sculpted crankcase and gear train refinements.

Hydraulics

Cat hydraulics deliver power and precise control to keep material moving.

Component Layout. The hydraulic system and component locations have been designed to provide a high level of system efficiency. The main pumps, control valves and hydraulic tank are located close together. This allows for shorter tubes and lines between components, which reduce friction loss, and pressure drops in the lines. The layout further provides greater operator comfort by placing the radiator on the cab side of the upper structure. This allows incoming air to enter the engine compartment from the operator side. Hot air and corresponding engine sound exits on the opposite side away from the operator. This reduces engine compartment heat and sound being transmitted to the operator.

Pilot System. The pilot pump is independent from the main pumps and controls the front linkage, swing and travel operations.

Hydraulic Cross Sensing System.

The hydraulic cross sensing system utilizes each of two hydraulic pumps to 100 percent of engine power, under all operating conditions. This improves productivity with faster implement speeds and quicker, stronger pivot turns.

Boom and Stick Regeneration Circuit.

Boom and stick regeneration circuit saves energy during boom-down and stick-in operation. This increases operator efficiency, reduces cycle times and pressure loss. Benefits include higher productivity, lower operating costs and increased fuel efficiency.



Auxiliary Hydraulic Valve. The auxiliary valve is standard on the 328D LCR. Control Circuits are available as attachments, allowing for operation of high and medium pressure tools. These include shears, grapples, hammers, pulverizers, multi-processors and vibratory plate compactors.

Hydraulic Cylinder Snubbers.

Snubbers are located at the rod-end of the boom cylinders and both ends of the stick cylinders. Benefits include reducing sound levels, cushion shocks while extending component life.

Operator Station

Designed for simple, easy operation and comfort, the 328D LCR allows the operator to focus on production.



Operator Station. The workstation is spacious, quiet and comfortable, assuring high productivity during a long workday. The attachment switches, key switch and throttle dial are conveniently located on the right-hand wall. The monitor is easy to see and maximizes visibility.

Joystick Control. The joystick controls are designed for low lever effort and match operator's natural wrist and arm position. The operator can operate the joystick controls with an arm on the armrest. Horizontal and vertical strokes have been designed to reduce operator fatigue.



Seat. The air suspension seat is standard in the 328D LCR, provides a variety of adjustments to suit the operator's size and weight including fore/aft, height and weight. Wide adjustable armrest and a retractable seat belt are also included

Automatic Climate Control. Fully automatic climate control adjusts temperature and flow, and determines which air outlet is best in each situation with a touch of a button.

Hydraulic Activation Control Lever. For added safety, this lever must be in the operate position to activate the machine control functions.

Skylight. An enlarged skylight with sunshade provides excellent visibility and ventilation.

Door. The 328D LCR features a curved sliding door. This feature is ideal for those situations when space is restricted and opening a conventional door is not permissible.

Windows. All glass is affixed directly to the cab for excellent visibility eliminating window frames. The upper front windshield opens, closes and stores on the roof above the operator with a one-touch action release system.

Wipers. Pillar-mounted wipers increase the operator's viewing area and offer continuous and intermittent modes.



Console. Redesigned consoles feature a simple, functional design to reduce operator fatigue, ease of switch operation and excellent visibility. Both consoles have attached armrests with height adjustments.

Cab Exterior. The exterior design uses thick steel tubing along the bottom perimeter of the cab, improving the resistance of fatigue and vibration. This design allows the FOGS to be bolted directly to the cab, at the factory or as an attachment later, enabling the machine to meet specifications and job site requirements.

Cab Mounts. The cab shell is attached to the frame with viscous rubber cab mounts, which dampen vibrations and sound levels while enhancing operator comfort.

Standard Cab Equipment. To enhance operator comfort and productivity, the cab includes a drink holder, coat hook, service meter, literature holder and magazine rack.

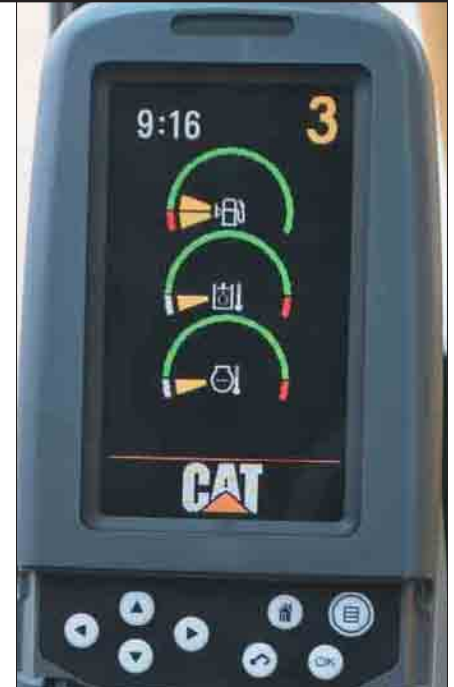

Monitor. The monitor is a full color 400 x 234 pixels Liquid Crystal Display (LCD) graphic display. The angle can be adjusted to minimize sun glare and has the capability of displaying information in twenty-seven different languages.

Pre-Start Check. Prior to starting the machine, the system will check for low fluid levels. These include engine oil, hydraulic oil and engine coolant. The event display area warns the operator if one of the conditions exists.

Gauge Display. Three analog gauges, fuel level, hydraulic oil temperature and coolant temperature, are displayed in this area.

Event Display. Machine information is displayed in this area with the icon and language.

Multi-information Display. This area is reserved for displaying various information which is convenient for the operator. The "CAT" logo is displayed when no information is available to be displayed.

Structures

Structural components and undercarriage are the backbone of the machine's durability.

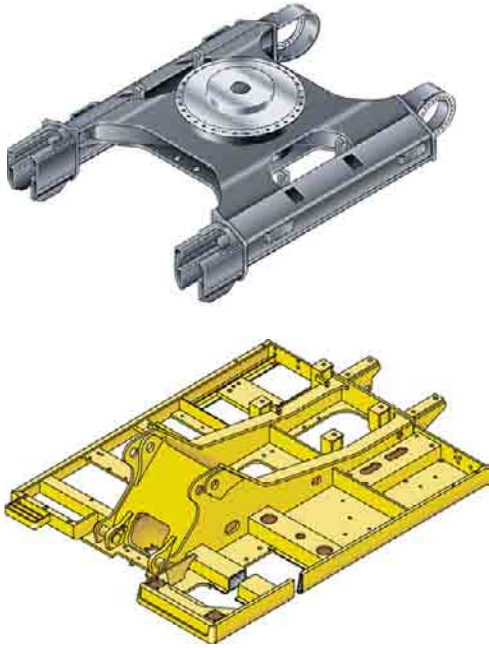

Robotic Welding. Up to 95% of the structural welds on a Caterpillar Excavator are completed by robots. Robotic welds achieve over three times the penetration of manual welds.

Carbody Design and Track Roller Frames. X-shaped, box-section carbody provides excellent resistance to torsional bending. Robot-welded track roller frames are press-formed, pentagonal units to deliver exceptional strength and service life.

Main Frame. Rugged main frame is designed for maximum durability and efficient use of materials.

Swing Bearing. The swing bearing utilizes cross roller bearings versus the traditional ball bearing design. The cross roller bearing design allows for more surface contact to absorb the

stresses that are a result of the high swing torque that Cat offers. It provides exceptional machine stability and reduces machine pitching during boom down operation.

Undercarriage. Durable Cat undercarriage absorbs stresses and provides excellent stability.

Rollers and Idlers. Sealed and lubricated track rollers, carrier rollers, and idlers provide excellent service life, to keep the machine in the field longer.

Long Undercarriage. The long (L) undercarriage maximizes stability and lift capacity. Two additional track links have been added to the 328D LCR. This long, wide, and sturdy undercarriage offers a very stable work platform.

Booms, Sticks and Linkage

Designed for flexibility, high productivity, and efficiency in a variety of applications.

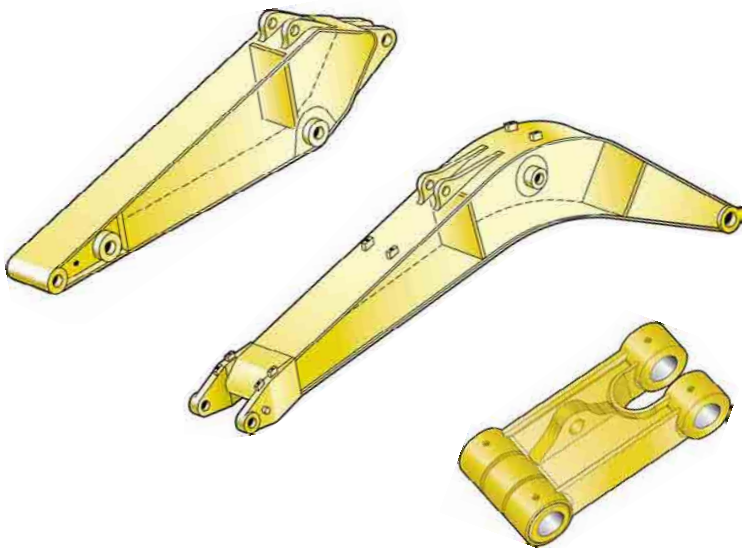

Reach Boom. The reach boom (6150 mm) is designed to balance reach, digging force bucket capacity, offering a wide range of applications as digging, loading, trenching and working with hydraulic tools.

R3.2CB2 Stick. The CB-family buckets associated with these sticks have enough capacity for excellent reach and depth in trenching and general construction applications.

Linkage Pins. The bucket linkage pins have been enlarged to improve reliability and durability. All the pins in the front linkages have thick chrome plating, giving them high wear and corrosion resistance.

Bucket Linkage. The power link improves durability, increases machine-lifting capability in key lifting positions and with the integrated lift-eye it is easier to use than compared to the previous power link.

Service and Maintenance

Simplified service and maintenance save you time and money.

Ground Level Service. The design and layout was made with the service technician in mind. Many service locations are easily accessible at ground level allowing critical maintenance to get done quickly and efficiently.

Air Filter Compartment. The air filter features a double-element construction for superior cleaning efficiency. When the air cleaner plugs, a warning is displayed on the monitor screen inside the cab.

Pump Compartment. A service door on the right side of the upper structure allows ground-level access to the pump and pilot filter.

Radiator Compartment. The left rear service door allows easy access to the engine radiator, oil cooler and air-to-air-after-cooler. A reserve tank and drain cock are attached to the radiator for simplified maintenance.

Greasing Points. A concentrated remote greasing block on the boom delivers grease to hard-to-reach locations on the front.

Fan Guard. Engine radiator fan is completely enclosed by fine wire mesh, reducing the risk of an accident.

Anti-Skid Plate. Anti-skid plate covers top of storage box and upper structure to prevent slipping during maintenance.

Diagnostics and Monitoring. The 328D LCR is equipped with S•O•SSM sampling and hydraulic test ports for the hydraulic system, engine oil, and for coolant. A test connection for the Cat Electronic Technician (Cat ET) service tool is located in the cab.

Extended Service Interval. 328D LCR service and maintenance intervals have been extended to reduce machine service time and increase machine availability.



Complete Customer Support

Cat dealer services help you operate longer with lower costs.

Machine Selection. Make detailed comparisons of the machines you are considering before you buy. What are the job requirements, machine attachments and operating hours? What production is needed? Your Cat dealer can provide recommendations.

Purchase. Consider the financing options available as well as day-to-day operating costs. This is also the time to look at dealer services that can be included in the cost of the machine to yield lower equipment owning and operating costs over the long run.

Customer Support Agreements. Cat dealers offer a variety of product support agreements, and work with customers to develop a plan the best

meets specific needs. These plans can cover the entire machine, including attachments, to help protect the customer's investment.

Operation. Improving operating techniques can boost your profits. Your cat dealer has videotapes, literature and other ideas to help you increase productivity, and Caterpillar offers certified operator training classes to help maximize the return on your investment.

Product Support. You will find nearly all parts at our dealer parts counter. Cat dealers utilize a worldwide computer network to find in-stock parts to minimize machine downtime. You can save money with Cat remanufactured components.



Maintenance Services. Repair option programs guarantee the cost of repairs up front. Diagnostic programs such as Scheduled Oil Sampling, Coolant Sampling and Technical Analysis help you avoid unscheduled repairs.

Replacement. Repair, rebuild or replace? Your Cat dealer can help you evaluate the cost involved so you can make the right choice.

Work Tools

A wide variety of Work Tools help optimize machine performance. Purpose designed and built to Caterpillar's high durability standards.

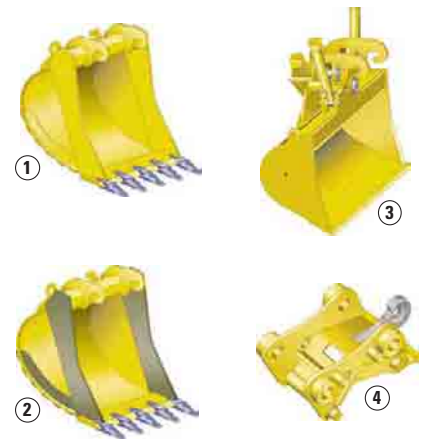

- 1 Excavation (X)
- 2 Extreme Excavation (EX)
- 3 Ditch Cleaning
- 4 Quick Coupler

Work Tools. Caterpillar work tools are designed to function as an integral part of your excavator and to provide the best possible performance in your particular application. All work tools are performance-matched to Cat machines.

Quick Couplers. Quick couplers enable the operator to simply release one work tool and connect to another, making your hydraulic excavator highly versatile. Productivity also increases, as a carrier no longer needs to be idle between jobs. Caterpillar offers hydraulic and spindle quick coupler versions.

Buckets. Caterpillar offers a wide range of specialized buckets, each designed and tested to function as an integral part of your excavator. Buckets feature the new Caterpillar K Series™ Ground Engaging Tools.

Hammers. Cat hammer series deliver very high blow rates, increasing the productivity of your tool carriers in demolition and construction applications. Wide oil flow acceptance ranges make the Caterpillar hammers suitable for a wide range of carriers and provide a system solution from one safe source.

Orange Peel Grapples. The orange peel grapple is constructed of high-strength, wear-resistant steel, with a low and compact design that makes it ideal for dump clearance. There are several choices of tine and shell versions.

Multi-Grapples. The multi-grapple with unlimited left and right rotation is the ideal tool for stripping, sorting, handling and loading. The powerful closing force of the grab shells combined with fast opening/closing time ensures rapid cycle time which translates to more tons per hour.

Multi-Processors. Thanks to its single basic housing design, the multi-processor series of hydraulic demolition equipment makes it possible to use a range of jaw sets that can handle any demolition job. The multi-processor is the most versatile demolition tool on the market.



Vibratory Plate Compactors.

Cat compactors are performance-matched to Cat machines, and integrate perfectly with the Cat hammer line – brackets and hydraulic kits are fully interchangeable between hammers and compactors.

Shears. Cat shears provide superior and effective scrap processing, and are highly productive in demolition environments. Shears are compatible with a matching Cat excavator, and bolt-on brackets are available for either stick or boom-mounted options.

Work Tools Matching Guide

Without quick coupler		
Hammers		H120C S, H130 S, H140D S
Multiprocessors		MP20 CC, CR, PP, PS, S, TS
		MP30 CC, CR, S, TS
		MP30 PP, PS
Crushers and Pulverizers		VHC-40
		VHC-50
		VHP-40
		VHP-50
Hydraulic Shears		S320
		S325
		S340*
Mechanical Grapples		G115
		G125
Multi Grapples		G320
		G330
		G320B-D, -R
Vibratory Plate Compactor		CVP110
Clamshell Buckets (rehandling)		GOS-35 620, 700, 780
		GOS-35 1050, 1260
		GOS-35 1460, 1670
		GOS-45 970
		GOS-45 1120
		GOS-45 1270
		GOS-45 1580
		GOS-45 1710
		GOS-45 2020
		GOS-45 2340
Orange Peel Grapples	5 tines	GSH20B 600, 800
		GSH20B 1000
		GSH22B 600
		GSH22B 800
		GSH22B 1000
	4 tines	GSH22B 1250
		GSH20B 600, 800, 1000
		GSH22B 600
		GSH22B 800
		GSH22B 1000
		GSH22B 1250
* Boom mounted		
With quick coupler		
Quick Couplers		CW-45
		CW-45S
Hammers		H120C S, H130 S, H140D S
Multiprocessors		MP20 CC, CR, PS, S
		MP20 PP, TS
Crushers and Pulverizers		VHC-40
		VHC-50
		VHP-40
		VHP-50
Hydraulic Shears		S320
		S325
Mechanical Grapples		G115
		G125
		G315
Multi Grapples		G320
		G330
		G320B-D, -R
		CVP110

 360° Working range	 Best choice	 Max. Material Density 1200 kg/m³	 N Not recommended
 Over the front only	 Quick coupler match	 Max. Material Density 1800 kg/m³	 Max. Material Density 3000 kg/m³

Engine

Cat C7 with ACERT Technology	
Net Power at 1800 rpm	
ISO 9249	140 kW/190 hp
80/1269/EEC	140 kW/190 hp
Bore	110 mm
Stroke	127 mm
Displacement	7.2 liters

- All engine horsepower (hp) are metric including front page.
- The C7 engine meets Stage IIIA emission requirements.
- Net power advertised is the power available at the flywheel when the engine is equipped with fan, air cleaner, muffler, and alternator.
- Full engine net power up to 2300 m altitude (engine derating required above 2300 m).

Hydraulic System

Main System	
Maximum flow	2 x 235 l/min
Maximum pressure	
Normal	350 bar
Heavy lift	360 bar
Travel	350 bar
Swing	275 bar
Pilot System	
Maximum flow	32.4 l/min
Maximum pressure	39 bar
Boom Cylinder	
Bore	140 mm
Stroke	1407 mm
Stick Cylinder	
Bore	150 mm
Stroke	1646 mm
CB2 Family Bucket Cylinder	
Bore	135 mm
Stroke	1156 mm

Drive

Maximum Travel Speed	4.2 km/h
Maximum Drawbar Pull	300 kN

Swing Mechanism

Swing Speed	10.2 rpm
Swing Torque	82.2 kNm

Cab/FOGS

Cab/FOGS meets ISO 10262.

Sound

The dynamic exterior sound power level meets EU Directive 2000/14/EC.

Machine and Major Component Weights

Actual weights and ground pressures will depend on final machine configuration.

	kg
Base machine with counterweight (without front linkage) with 850 mm shoes	30 400
Two boom cylinders (each)	240
Standard counterweight	7720
Reach boom (6150 mm), includes lines, pins and stick cylinder	2300
Long stick (3200 mm), includes lines, pins, bucket cylinder and linkage	1390

Service Refill Capacities

	Liters
Fuel Tank	406
Cooling System	32
Engine Oil	32
Swing Drive (each)	10
Final Drive (each)	8
Hydraulic system (including tank)	290
Hydraulic tank	153

Track Width

Optional	850 mm
Optional	600 mm
Number of Shoes Each Side	49
Number of Track Rollers Each Side	9
Number of Carrier Rollers Each Side	2

Dimensions

All dimensions are approximate.

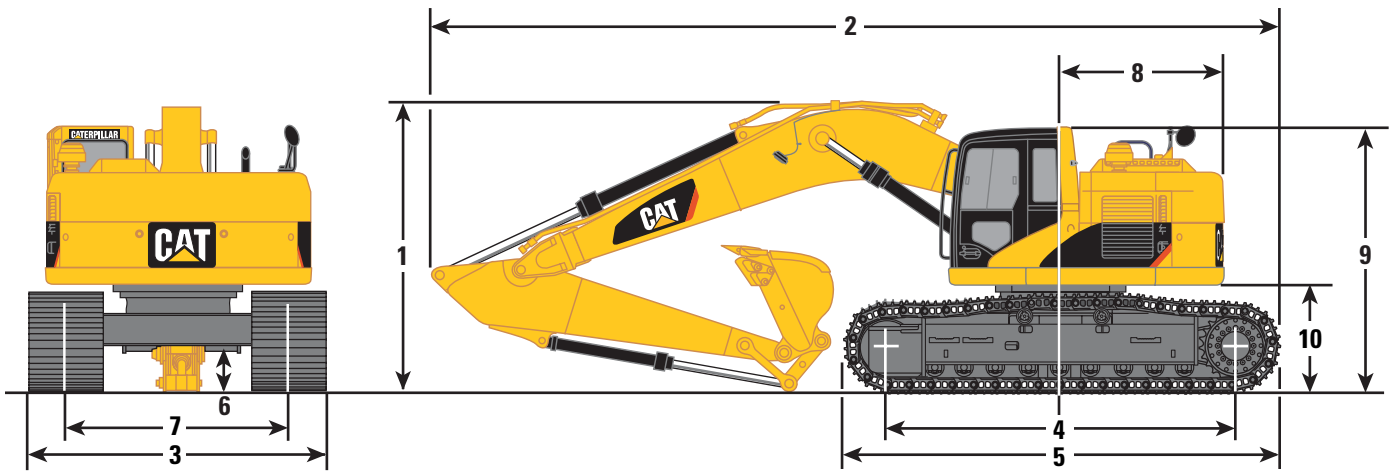

	mm		mm
Reach Boom	6150	7 Track Gauge	2590
Long Stick R3.2CB2	3200	8 Transport Width	
1 Shipping Height	3370	850 mm shoes	3440
2 Shipping Length	9820	700 mm shoes	3290
3 Tail Swing Radius	1900	600 mm shoes	3190
4 Length to Center of Idler and Sprocket	4040	9 Cab Height	3190
5 Track Length	5020	10 Counterweight Clearance	1200
6 Ground Clearance	510		

Bucket Specifications

	Linkage	Width	Weight*	Capacity (ISO)	Fill Factor	Without Quick Coupler	With Quick Coupler
		mm	kg	m ³	%	Stick 3200 mm	Stick 3200 mm
Excavation	CB2	600	646	0.49	100		
	CB2	750	688	0.67	100		
	CB2	1250	919	1.29	100		
	CB2	1300	958	1.35	100		
	CB2	1350	979	1.42	100		
	CB2	1400	1000	1.48	100		
	CB2	1500	1043	1.61	100		
Extreme Excavation	CB2	1600	1084	1.74	100		
	CB2	750	724	0.66	100		
	CB2	1150	926	1.16	100		
	CB2	1350	1014	1.42	100		
	CB2	1450	1083	1.55	100		
	CB2	1500	1104	1.61	100		
	CB2	1600	1148	1.74	100		
Maximum load in kg (payload plus bucket)						4098	3848

* Bucket weight including penetration plus tips

Max. Material Density 1500 kg/m³

Max. Material Density 1800 kg/m³

Working Range – Reach Boom (6150 mm)

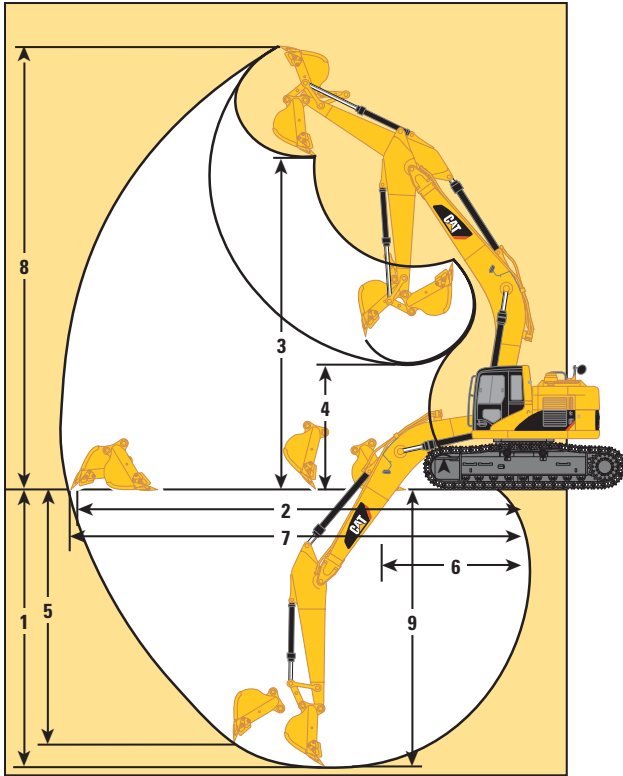

















R3.2CB2

Stick Length	mm	3200
1 Maximum Digging Depth	mm	6920
2 Maximum Reach at Ground Level	mm	10 560
3 Maximum Loading Height	mm	8040
4 Minimum Loading Height	mm	2990
5 Maximum Vertical Wall Digging Depth	mm	6260
6 Minimum Front Swing Radius	mm	3400
7 Maximum Reach	mm	10 770
8 Maximum Cutting Height	mm	11 110
9 Maximum Digging Depth 2500 mm Level Bottom	mm	6760
Bucket HD	m ³	1.2
Bucket Force (ISO 6015)	kN	179
Stick Force (ISO 6015)	kN	130

Lift Capacities – Reach Boom (6150 mm)

All weights are in kg. Heavy Lift On.

Long Stick
3200 mm
Shoes
850 mm

	1.5 m		3.0 m		4.5 m		6.0 m		7.5 m		9.0 m				m	
																
9.0 m														*4200	*4200	7.85
7.5 m									*6100	*6100				*4000	*4000	9.05
6.0 m							*8000	*8000	*6550	6500				*3900	*3900	9.80
4.5 m					*10 800	*10 800	*9050	8750	*8050	6350	*6000	4850	*3950	*3950	10.24	
3.0 m					*13 550	12 500	*10 350	8350	*8750	6150	*7450	4750	*4100	3900	10.40	
1.5 m					*15 700	11 650	*11 550	7950	*9350	5950	7450	4650	*4300	3900	10.30	
0 m			*7000	*7000	*16 550	11 200	*12 200	7650	9500	5750	*7400	4600	*4700	4050	9.94	
-1.5 m	*7450	*7450	*11 100	*11 100	*16 200	11 100	*12 200	7500	9400	5700			*5300	4400	9.29	
-3.0 m	*11 850	*11 850	*16 600	*16 600	*14 850	11 150	*11 350	7550	*8750	5700			*6400	5200	8.26	
-4.5 m			*16 150	*16 150	*12 200	11 400	*9200	7700					*5650	*5650	6.66	



Load Point Height



Load Radius Over Front



Load Radius Over Side



Load at Maximum Reach

* Limited by hydraulic rather than tipping load.

The above loads are in compliance with hydraulic excavator lift capacity ratings standard ISO 10567, they do not exceed 87% of hydraulic lifting capacity or 75% of tipping capacity. Weight of all lifting accessories must be deducted from the above lifting capacities.

Standard Equipment

Standard equipment may vary. Consult your Caterpillar dealer for specifics.

Electrical

65 Ampere alternator
Heavy duty maintenance free batteries
Lights working
Frame mounted
Cab mounted
Boom mounted
Signal/warning Horn
Pre-Start monitoring system – checks for low fluids (engine oil, coolant, hydraulic oil) prior to starting machine

Operator Environment

Air conditioner, heater, defroster with automatic climate control
AM/FM Radio with antenna and 2 speakers
Ashtray
Beverage/cup holder
Bolt-on Falling Object Guarding System (FOGS) capability
Coat Hook
Converter, 5A-12V
Floor mat, washable
Instrument panel and gauges
Joysticks thumb wheel, console mounted, pilot operated
Light, interior
Literature compartment
Mirrors – left and right
Monitor, full graphic color display
Neutral lever (lock out) for all controls
Openable and retractable two-piece front windshield

Polycarbonate side windows
Positive filtered ventilation,
Pressurized cab
Rear window, emergency exit
Seat, suspension, with high back and head rest
Seat belt, retractable
Sun shade (for skylight)
Sky-light, pop-up, polycarbonate
Travel control pedals with removable hand levers
Windshield wiper and washer

Engine/Power Train

Cat C7 ACERT
Air Intake Heater
Air-to-air Aftercooler (ATAAC)
24V Electric Starting
Hydraulic electronic unit injectors (HEUI)
2300 m Altitude capability without derate
Automatic engine speed control with one touch low idle
Cooling
Protection of 43°C to -18°C at 50% concentration
Electric Priming Pump
Straight line travel
Two speed auto-shift travel
Water separator in fuel line
Water level indicator for water separator

Guards

Heavy duty bottom guards on upper frame

Heavy duty travel motor guards on undercarriage
Track guiding guard, full length
Swivel guard on undercarriage

Hydraulics

Auxiliary boom lines (high pressure and medium pressure)
Tool Control
Combined function (one way high pressure circuit for hammer application, function for 1-way or 2-way high pressure)
Medium pressure circuit
Tool selection (via monitor 10 tools)

Undercarriage

Grease lubricated track
Heavy-duty rollers
Hydraulic track adjusters
Idler and center section track guards
Step – Six

Other Standard Equipment

Automatic swing parking brake
Boom lowering control device
Booms Reach 6150 mm
Counterweight – 7720 kg
Caterpillar one key security system with locks for doors, cab and fuel cap
Fine swing control
Fully pressurized hydraulic system
Heavy Lift mode
S•O•SSM quick sampling valves for engine and hydraulic oil
Travel Alarm
Wiring provision for Product Link

Optional Equipment

Optional equipment may vary. Consult your Caterpillar dealer for specifics.

Front Linkage

Stick Reach 3200 mm
Bucket Linkage CB2 Family

Guarding

Falling Object Guarding System (FOGS)

Engine/Power Train

Prefilter, Air
Starting, Cold Weather Package
Two additional maintenance free batteries
High capacity starter motor
Heavy-duty cable
Jump-start receptacle
Either aid
Block heater

Undercarriage

Track Shoes (mandatory attachment)
600 mm triple grouser
850 mm triple grouser

Miscellaneous Options

Blade, 3190 mm wide
Plate new machine certificate
Device SLCV Reach Boom
Auxiliary stick lines (high pressure and medium pressure)

328D LCR Hydraulic Excavators

For more complete information on Cat products, dealer services, and industry solutions, visit us on the web at www.cat.com

Materials and specifications are subject to change without notice. Featured machines in photos may include additional equipment. See your Caterpillar dealer for available options.

© 2007 Caterpillar -- All rights reserved

CAT, CATERPILLAR, their respective logos, "Caterpillar Yellow" and the POWER EDGE trade dress as well as corporate and product identity used herein, are trademarks of Caterpillar and may not be used without permission.

HEHH3329-1 (03/2007) hr

CATERPILLAR[®]